

HITACHI

Inspire the Next

PM

NO. 0269E

SERVICE MANUAL

TECHNICAL INFORMATION

RAK-18NH5
RAK-25NH5
RAK-35NH5

FOR SERVICE PERSONNEL ONLY

REFER TO THE FOUNDATION MANUAL

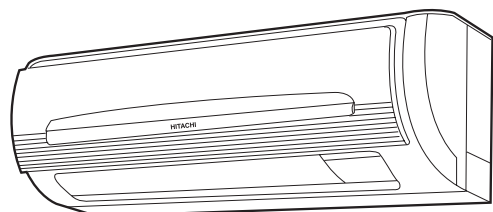

RAK-18NH5
RAK-25NH5
RAK-35NH5



CONTENTS

SPECIFICATIONS	5
HOW TO USE	12
CONSTRUCTION AND DIMENSIONAL DIAGRAM	36
MAIN PARTS COMPONENT	37
WIRING DIAGRAM	38
CIRCUIT DIAGRAM	39
PRINTED WIRING BOARD LOCATION DIAGRAM	43
BLOCK DIAGRAM	45
BASIC MODE	47
REFRIGERATING CYCLE DIAGRAM	61
AUTO SWING FUNCTION	63
DESCRIPTION OF MAIN CIRCUIT OPERATION	64
SERVICE CALL Q & A	69
PARTS LIST AND DIAGRAM	79

NOTE:

This manual describes only points that differ from RAF-25, 35NH5, RAD-25, 35NH5, RAI-25, 35NH5 and RAM-40QH5 (PM No. 0270E) for items not described in this manual.

SPECIFICATIONS

TYPE		DC INVERTER (WALL TYPE)		
		INDOOR UNIT		
MODEL		RAK-18NH5	RAK-25NH5	RAK-35NH5
POWER SOURCE		1 PHASE, 50 Hz, 220-240V		
COOLING	TOTAL INPUT (W)	REFER TO THE SPECIFICATION PAGE (6)		
	TOTAL AMPERES (A)			
	CAPACITY (kW)			
	(B.T.U./h)			
HEATING	TOTAL INPUT (W)			
	TOTAL AMPERES (A)			
	CAPACITY (kW)			
	(B.T.U./h)			
DIMENSIONS (mm)	W	780		
	H	280		
	D	210		
NET WEIGHT (kg)		9.0	9.5	9.5

SPECIFICATIONS AND PARTS ARE SUBJECT TO CHANGE FOR IMPROVEMENT



PM AIR CONDITIONER

Большая библиотека технической документации
<https://splitsystema48.ru/instrukcii-po-ekspluatacii-kondicionerov.html>
 каталоги, инструкции, сервисные мануалы, схемы.

SEPTEMBER

Division

SAFETY DURING REPAIR WORK

1. In order to disassemble and repair the unit in question, be sure to disconnect the power cord plug from the power outlet before starting the work.

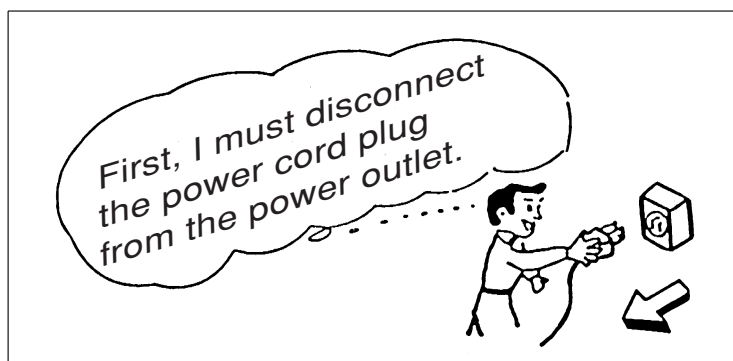

2. If it is necessary to replace any parts, they should be replaced with respective genuine parts for the unit, and the replacement must be effected in correct manner according to the instructions in the Service Manual of the unit.

If the contacts of electrical parts are defective, replace the electrical parts without trying to repair them.



3. After completion of repairs, the initial state should be restored.
4. Lead wires should be connected and laid as in the initial state.
5. Modification of the unit by user himself should absolutely be prohibited.
6. Tools and measuring instruments for use in repairs or inspection should be accurately calibrated in advance.
7. In installing the unit having been repaired, be careful to prevent the occurrence of any accident such as electrical shock, leak of current, or bodily injury due to the drop of any part.
8. To check the insulation of the unit, measure the insulation resistance between the power cord plug and grounding terminal of the unit. The insulation resistance should be $1M\Omega$ or more as measured by a 500V DC megger.
9. The initial location of installation such as window, floor or the other should be checked for being and safe enough to support the repaired unit again. If it is found not so strong and safe, the unit should be installed at the initial location reinforced or at a new location.
10. Any inflammable thing should never be placed about the location of installation.
11. Check the grounding to see whether it is proper or not, and if it is found improper, connect the grounding terminal to the earth.



WORKING STANDARDS FOR PREVENTING BREAKAGE OF SEMICONDUCTORS

1. Scope

The standards provide for items to be generally observed in carrying and handling semiconductors in relative manufacturers during maintenance and handling thereof. (They apply the same to handling of abnormal goods such as rejected goods being returned).

2. Object parts

- (1) Micro computer
- (2) Integrated circuits (IC)
- (3) Field-effect transistors (FET)
- (4) P.C. boards or the like on which the parts mentioned in (1) and (2) of this paragraph are equipped.

3. Items to be observed in handling

- (1) Use a conductive container for carrying and storing of parts. (Even rejected goods should be handled in the same way).

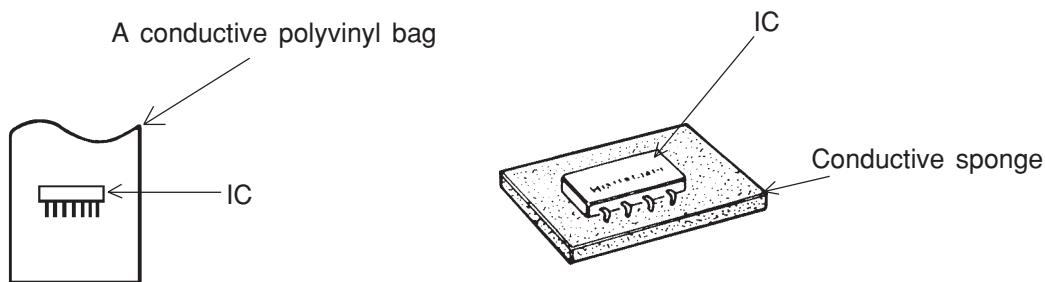

Fig. 1. Conductive Container

- (2) When any part is handled uncovered (in counting, packing and the like), the handling person must always use himself as a body earth. (Make yourself a body earth by passing one M ohm earth resistance through a ring or bracelet).
- (3) Be careful not to touch the parts with your clothing when you hold a part even if a body earth is being taken.
- (4) Be sure to place a part on a metal plate with grounding.
- (5) Be careful not to fail to turn off power when you repair the printed circuit board. At the same time, try to repair the printed circuit board on a grounded metal plate.

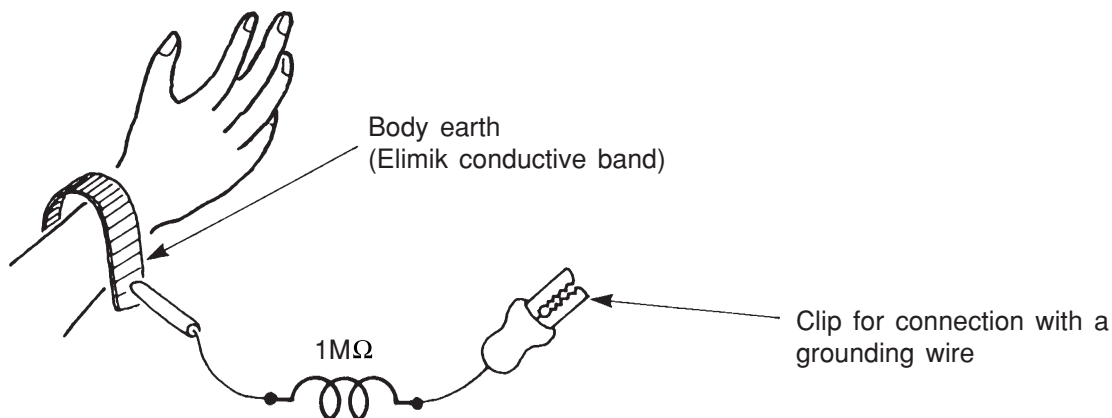

Fig. 2. Body Earth

(6) Use a three wire type soldering iron including a grounding wire.

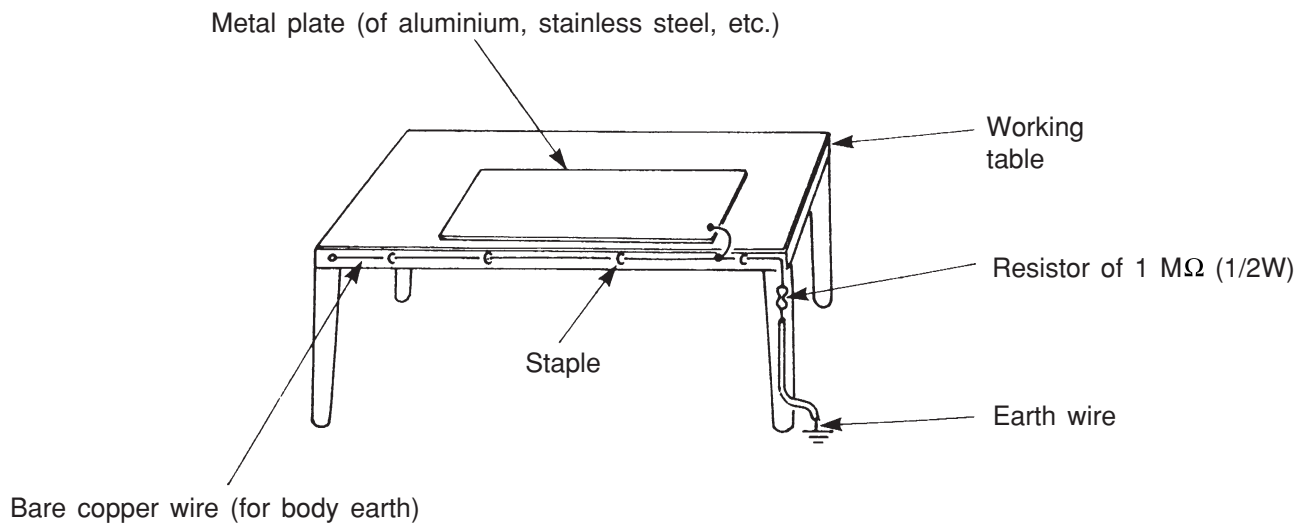

Fig. 3. Grounding of the working table

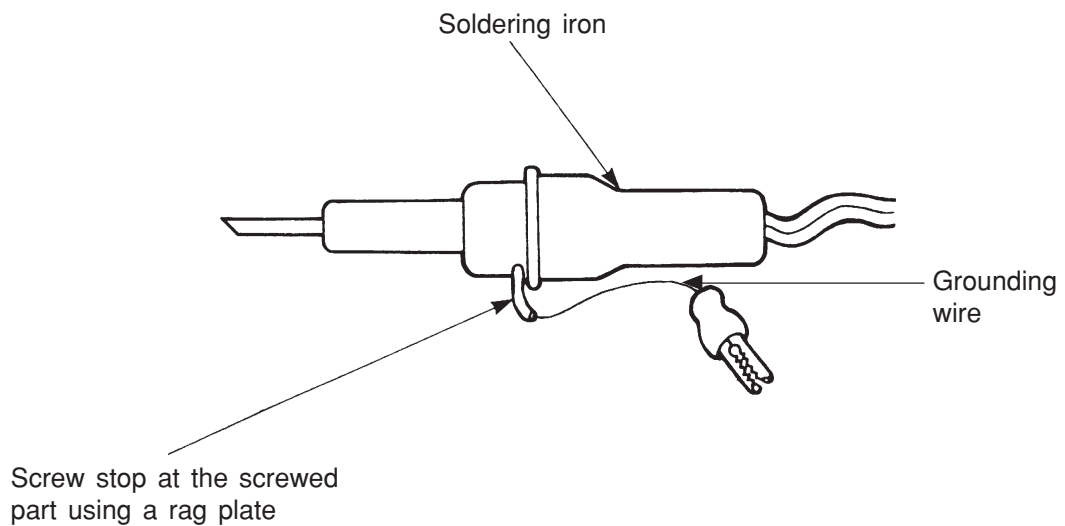

Fig. 4. Grounding a soldering iron

Use a high insulation mode (100V, 10MΩ or higher) when ordinary iron is to be used.

(7) In checking circuits for maintenance, inspection or some others, be careful not to have the test probes of the measuring instrument shortcircuit a load circuit or the like.

 **CAUTION**

1. In quiet operation or stopping the running, slight flowing noise of refrigerant in the refrigerating cycle is heard occasionally, but this noise is not abnormal for the operation.
2. When it thunders near by, it is recommend to stop the operation and to disconnect the power cord plug from the power outlet for safety.
3. The room air conditioner does not start automatically after recovery of the electric power failure for preventing fuse blowing. Re-press START/STOP button after 3 minutes from when unit stopped.
4. If the room air conditioner is stopped by adjusting thermostat, or missoperation, and re-start in a moment, there is occasion that the cooling and heating operation does not start for 3 minutes, it is not abnormal and this is the result of the operation of IC delay circuit. This IC delay circuit ensures that there is no danger of blowing fuse or damaging parts even if operation is restarted accidentally.
5. This room air conditioner should not be used at the cooling operation when the outside temperature is below -10°C (14°F).
6. This room air conditioner (the reverse cycle) should not be used when the outside temperature is below -15°C (5°F).
If the reverse cycle is used under this condition, the outside heat exchanger is frosted and efficiency falls.
7. When the outside heat exchanger is frosted, the frost is melted by operating the hot gas system, it is not trouble that at this time fan stops and the vapour may rise from the outside heat exchanger.

SPECIFICATIONS

MODEL	RAK-18NH5, RAK-25NH5, RAK-35NH5	
FAN MOTOR	35W	
FAN MOTOR CAPACITOR	NO	
FAN MOTOR PROTECTOR	NO	
COMPRESSOR	-	
COMPRESSOR MOTOR CAPACITOR	NO	
OVERLOAD PROTECTOR	NO	
OVERHEAT PROTECTOR	NO	
FUSE (for MICROPROCESSOR)	NO	
POWER RELAY	NO	
POWER SWITCH	NO	
TEMPORARY SWITCH	YES	
SERVICE SWITCH	NO	
TRANSFORMER	NO	
VARISTOR	NO	
NOISE SUPPRESSOR	NO	
THERMOSTAT	YES(IC)	
REMOTE CONTROL SWITCH (LIQUID CRYSTAL)	YES	
REFRIGERANT CHARGING VOLUME (Refrigerant 410A)	UNIT	-----
	PIPES	WITHOUT REFRIGERANT BECAUSE COUPLING IS FLARE TYPE.

SPECIFICATION OF ROOM AIR CONDITIONER

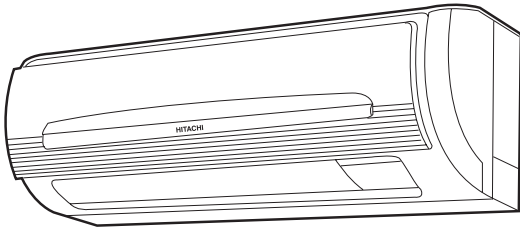

RAK-18NH5, RAK-25NH5, RAK-35NH5

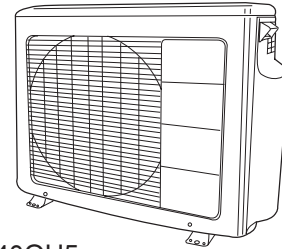

RAM-40QH5

TYPE	COOLING/HEATING			
	WALL TYPE			
MODEL	INDOOR UNIT	RAK-18NH5	RAK-25NH5	RAK-35NH5
	OUTDOOR UNIT	RAM-40QH5		
PHASE/VOLTAGE/FREQUENCY	1ø / 220V~240V / 50Hz			
COOLING (ONE UNIT)	CAPACITY (kW) (BTU/h)	1.8 (1.00 - 2.50) 6,150 (3,410 - 8,525)	2.5 (1.00 - 3.10) 8,540 (3,410 - 10,580)	3.5 (1.00 - 4.00) 11,950 (3,410 - 13,660)
	TOTAL INPUT (W)	560 (200 - 750)	750 (200 - 880)	1,090 (200 - 1,300)
	COP	3.21	3.33	3.21
	TOTAL AMPERE (A)	2.57 - 2.36	3.44 - 3.16	5.00 - 4.59
	POWER FACTOR (%)	99	99	99
	SOUND LEVEL (INDOOR)	35	38	41
	AIR FLOW VOLUME (Hi)	7	8	10
COOLING (2 UNITS) RAK-25NH5+RAK-35NH5RAM-40QH5	CAPACITY (kW) (BTU/h)	4.0 (1.50 - 4.50) 13,660 (5,120 - 15,360)		
	TOTAL INPUT (W)	1,245 (200 - 1,800)		
	COP	3.21		
	TOTAL AMPERE (A)	5.72 - 5.24		
	POWER FACTOR (%)	99		
	SOUND LEVEL (OUTDOOR)	49		
HEATING (ONE UNIT)	CAPACITY (kW) (BTU/h)	2.5 (1.10 - 3.20) 8,540 (3,750 - 10,920)	3.4 (1.10 - 4.40) 11,610 (3,750 - 15,013)	4.2 (1.10 - 5.00) 14,340 (3,750 - 17,060)
	TOTAL INPUT (W)	690 (200 - 970)	870 (200 - 1,120)	1,080 (200 - 1,300)
	COP	3.62	3.91	3.89
	TOTAL AMPERE (A)	3.17 - 2.90	3.99 - 3.66	4.96 - 4.55
	POWER FACTOR (%)	99	99	99
	SOUND LEVEL (INDOOR)	36	39	41
	AIR FLOW VOLUME (Hi)	7.5	8.5	10
HEATING (2 UNITS) RAK-25NH5+RAK-35NH5RAM-40QH5	CAPACITY (kW) (BTU/h)	5.0 (1.50 - 5.60) 17,070 (5,120 - 19,120)		
	TOTAL INPUT (W)	1,350 (200 - 1,780)		
	COP	3.70		
	TOTAL AMPERE (A)	6.20 - 5.68		
	POWER FACTOR (%)	99		
	SOUND LEVEL (OUTDOOR)	51		
AUTOMATIC AIR DEFLECTORS	YES	YES	YES	
FAN SPEED	4	4	4	
LINE CORD	NOT PROVIDED (POWER CORD SHOULD BE PREPARED AND CONNECTED TO OUTDOOR UNIT WHEN INSTALLED)			
REMOTE CONTROL SWITCH	YES (WIRELESS)	YES (WIRELESS)	YES (WIRELESS)	
MAXIMUM LENGTH OF PIPING	MAX 35m (TWO UNITS TOTAL)			
DIMENSIONS inches (mm)	W	30-23/32 (780)	30-23/32 (780)	30-23/32 (780)
	H	11-1/32 (280)	11-1/32 (280)	11-1/32 (280)
	D	8-9/32 (210)	8-9/32 (210)	8-9/32 (210)
	(INSTALLED)	-	-	-
NET WEIGHT (kg)				
PACKING inches (mm)	W	32-1/2 (826)	32-1/2 (826)	32-1/2 (826)
	H	10 (254)	10 (254)	10 (254)
	D	12-13/16 (325)	12-13/16 (325)	12-13/16 (325)
	cu.ft	2.42	2.42	2.42
GROSS WEIGHT (kg)	9	9.5	9.5	
FLARE NUT SIZE (SMALL/LARGE)	6.35/9.52	6.35/9.52	6.35/9.52	

DUAL SYSTEM MULTI R.A.C. RAK-18NH5, RAK-25NH5, RAK-35NH5 COOL / HEAT CAPACITY SPEC. FOR INDOOR UNITS COMBINATIONS TO BE ABLE TO OPERATE SIMULTANEOUSLY

Whichever indoor units are installed, cooling and heating capacity depends on how many and which indoor units are operating at that time.

POSSIBLE COMBINATIONS TO OPERATE		COOLING				HEATING			
		CAPACITY RATING (kW) (RANGE)		OUTDOOR UNIT		CAPACITY RATING (kW) (RANGE)		OUTDOOR UNIT	
		TOTAL	POWER CONSUMPTION (W)	AMPERE (A) at 230V	TOTAL	POWER CONSUMPTION (W)	AMPERE (A) at 230V		
ONE UNIT	1.8	1.8 (1.00-2.50)	1.8	560 (200-750)	2.5	2.5 (1.10-3.20)	2.5	690 (200-970)	3.0
	2.5	2.5 (1.00-3.10)	2.5	750 (200-880)	3.3	3.4 (1.10-4.40)	3.4	870 (200-1120)	3.8
	3.5	3.5 (1.00-4.00)	3.5	1090 (200-1300)	4.8	4.2 (1.10-5.0)	4.2	1080 (200-1300)	4.7
TWO UNIT	1.8+1.8	1.8+1.8 (1.50-4.00)	3.6	1190 (200-1680)	5.2	2.25+2.25 (1.50-5.20)	4.5	1100 (200-1480)	4.8
	1.8+2.5	1.70+2.30 (1.50-4.50)	4	1245 (200-1720)	5.5	2.20+2.60 (1.50-5.40)	4.8	1240 (200-1750)	5.4
	2.5+2.5	2.00+2.00 (1.50-4.50)	4	1245 (200-1800)	5.5	2.50+2.50 (1.50-5.60)	5	1350 (200-1780)	5.9
	1.8+3.5	1.60+2.40 (1.50-4.50)	4	1245 (200-1800)	5.5	1.70+3.30 (1.50-5.60)	5	1350 (200-1780)	5.9
	2.5+3.5	1.80+2.20 (1.50-4.50)	4	1245 (200-1800)	5.5	2.00+3.00 (1.50-5.60)	5	1350 (200-1780)	5.9

ONE UNIT : The values indicated are only for one unit operation when two indoor units are connected.

RATING CONDITON (DRY BLUB / WET BULB)

	INDOOR	OUTDOOR
COOLING	27 / 19 °C	35 / -°C
HEATING	20 / -°C	7 / 6°C

FEATURES

1. NEW REFRIGERANT

(1) New refrigerant R410A with no harmful effect on the ozone layer

Refrigerant R410A, which does not damage the ozone layer, was adopted instead of HCFC-22 which is planned to be phased out globally by 2020.

(2) New refrigerating oil

The new refrigerant HFC-R410A is not compatible with conventional mineral oils and no lubrication can be expected with those oils. To solve this, the artificial synthetic ester oil is newly adopted.

NEW TECHNOLOGY

Cautions in relation to HFC (R410A)

1. Safety during Servicing

This air conditioner uses the new refrigerant HFC (R410A) for protecting the ozone layer. R410A has several different characteristic features from HCFC-22. Therefore keep the following care items during servicing for safety.

- (1) Since the working pressure of R410A model is about 1.6 times higher than that of HCFC-22 models, it becomes necessary to use part of piping materials and servicing tools exclusive for R410A model.
- (2) It is necessary to exercise more care to prevent the foreign matters (oil, moisture, etc.) from mixing into the piping than in the case of HCFC-22 model. Also, when storing the piping, securely seal its openings with pinching and taping, etc..
- (3) Be sure to charge the refrigerant from the liquid-phase side, as the liquid-phase/gas-phase-composition changes a little in the case of R410A model.
- (4) Never use refrigerant other than R410A in an air conditioner which is designed to operate with R410A.
- (5) If a refrigeration gas leakage occurs during servicing, be sure to ventilate fully.
If the refrigerant gas comes into contact with fire, a poisonous gas may occur.
- (6) When installing or removing an air conditioner, do not allow air or moisture to remain in the refrigeration cycle. Otherwise, pressure in the refrigeration cycle may become abnormally high so that a rupture or personal injury may be caused.
- (7) After completion of service work, check to make sure that there is no refrigeration gas leakage.
If the refrigerant gas leaks into the room, coming into contact with fire in the fan-driven heater, space heater, etc., a poisonous gas may occur.

2. Refrigerant Piping Materials

(1) Thickness of Refrigerant Piping

Although the thickness is same as that for HCFC-22 model, as R410A model features higher pressure, be sure to confirm the thickness prior to use.

※Do not use thin pipes (thinner than 0.7 mm).

Nominal diameter	Outside diameter (mm)	Thickness (mm)
1/4	6.35	0.8
1/2	12.70	0.8

(2) Flare's Expansion Pipe

The projection when the new flare tool is used, is as follows. When using the conventional flare tool, be sure to secure the following projection by using a gauge for projection adjustment.

※When using the conventional flare tool, use a gauge for projection adjustment.

Projection "A"(mm) for Flare Tool for R410A (Clutch Type)

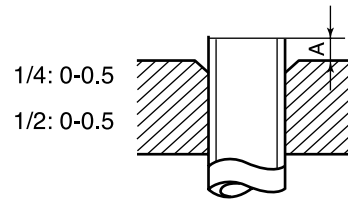

(3) Flare Nut Dimensions

Along with changes in the expansion pipe dimensions, the opposite side dimensions of flare nuts whose nominal diameter is 1/2 change so that different torque wrenches must be used.

※Figures in () denote those for HCFC-22.

Nominal diameter	Opposite Side Dimensions (mm) of Flare Nuts for R410A
1/4	17 (17)
3/8	22 (22)
1/2	26 (24)

3. Servicing Tools

(Changes in the Product and Components)

- In order to prevent any other refrigerant from being charged, R410A model is provided with the outdoor unit whose control valve has a different service port diameter (port size: 7/16 UNF 20 threads per inch → 1/2 UNF 20 threads per inch).
- In order to secure larger pressure resisting strength, flare expansion pipe dimensions and flare nut dimensions have been changed.

(New Tools for R410A)

New tools for R410A	Applicable to HCFC-22 Model	Changes
Gauge manifold	×	As pressure is high, it is impossible to measure by means of conventional gauge. In order to prevent any other refrigerant from being charged, each port diameter has been changed.
Charge hose	×	In order to increase pressure resistance, hose materials and port size have been changed (to 1/2 UNF 20 threads per inch). When purchasing a charge hose, be sure to confirm the port size.
Electronic balance for refrigerant charging	○	As pressure is high and gasification speed is fast, it is difficult to read the indicated value by means of charging cylinder, as air bubbles occur.
Torque wrench	×	The opposite side dimensions of flare nuts increase. Incidentally, a common wrench is used for nominal diameters 1/4 and 3/8.
Flare tool (clutch type)	○	By increasing the clamp bar's receiving hole, strength of spring in the tool has been improved.
Gauge for projection adjustment	–	Used when performing flare processing by means of conventional flare tool.
Vacuum pump adapter	○	Connected to conventional vacuum pump.
Gas leakage detector	×	Exclusive for HFC refrigerant.

- Incidentally, the "refrigerant cylinder" comes with the refrigerant designation (R410A) and protector coating in the U.S.'s ARI specified rose color (ARI color code: PMS 507).
- Also, the "charge port and packing for refrigerant cylinder" require 1/2 UNF 20 threads per inch corresponding to the charge hose's port size.

4. Servicing work (Refrigerant recharging)

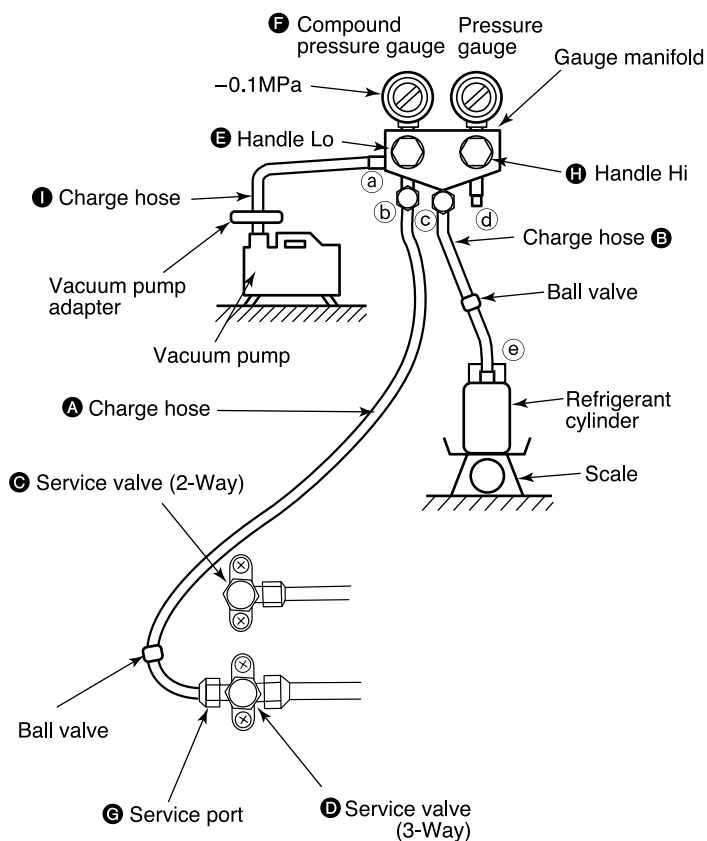

CAUTION

1. Be sure to use the vacuum pump, vacuum pump adapter and gauge manifold to refer to their instruction manuals beforehand.
2. Ascertain that the vacuum pump is filled with oil to the level designated on the oil gauge.
3. After closed the ball valve of charge hose, it should be disconnected at service port side and refrigerant cylinder side at first.
Next, after discharging the remained gas in the charge hose by opening the ball valve a little, disconnect it at gauge manifold side. You can prevent from being released the refrigerant suddenly by connecting the ball valve to service port. And you can work with more safety.



Working steps

1. Connect the charge hose **A** to outdoor unit.
2. Connect the vacuum pump adapter to the vacuum pump. Connect the 1/2" conversion adapter to the vacuum pump adapter. Connect the charge hose **1** to the conversion adapter.
Then, service valve **C** & **D** is closed.
3. Connect the charge hose **B** to the refrigerant cylinder.
4. Open the handle Lo **E**.
Turn ON the power switch of the vacuum pump & adapter.
Run the vacuum pump in specified time.
When the compound pressure gauge's pointer has indicated -0.1MPa, place the handle Lo **E** in the fully closed position.
Turn OFF the power switch of the vacuum pump & adapter.
6. Remove the charge hose **1** of vacuum pump at portion **a**.
7. Air purge of gauge manifold.
• Open the refrigerant cylinder's valve and push the valve core at portion **a** of gauge manifold. Then the refrigerant is discharge in a moment.
8. Calculation of charged refrigerant amount.
9. Charging of refrigeration.
• Open the handle Lo **E** in a turn and charge the designated amount.
10. Completion of charging.
11. Be closed the valve of charge hose **A**.
12. Run the compressor at cooling operation.
13. Remove the charge hose **A** & **B**.
• Remove the charge hose **A** rom portion **G**.
• Remove the charge hose **B** from portion **e**.
14. Attach the caps.
15. Gas leakage check.







SAFETY PRECAUTION

- Please read the “Safety Precaution” carefully before operating the unit to ensure correct usage of the unit.
- Pay special attention to signs of “**▲ Warning**” and “**▲ Caution**”. The “Warning” section contains matters which, if not observed strictly, may cause death or serious injury. The “Caution” section contains matters which may result in serious consequences if not observed properly. Please observe all instructions strictly to ensure safety.
- The sign indicate the following meanings.

 Make sure to connect earth line.	 The sign in the figure indicates prohibition.
 Indicates the instructions that must be followed.	

- Please keep this manual after reading.



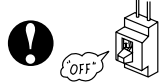

PRECAUTIONS DURING INSTALLATION

 WARNING	<ul style="list-style-type: none"> ● Do not reconstruct the unit. Water leakage, fault, short circuit or fire may occur if you reconstruct the unit by yourself. 	
	<ul style="list-style-type: none"> ● Please ask your sales agent or qualified technician for the installation of your unit. Water leakage, short circuit or fire may occur if you install the unit by yourself. 	
	<ul style="list-style-type: none"> ● Please use earth line. Do not place the earth line near water or gas pipes, lightning-conductor, or the earth line of telephone. Improper installation of earth line may cause electric shock. 	
 CAUTION	<ul style="list-style-type: none"> ● A circuit breaker should be installed depending on the mounting site of the unit. Without a circuit breaker, the danger of electric shock exists. 	
	<ul style="list-style-type: none"> ● Do not install near location where there is flammable gas. The outdoor unit may catch fire if flammable gas leaks around it. 	
	<ul style="list-style-type: none"> ● Please ensure smooth flow of water when installing the drain hose. 	

PRECAUTIONS DURING SHIFTING OR MAINTENANCE

 WARNING	<ul style="list-style-type: none"> ● Should abnormal situation arises (like burning smell), please stop operating the unit and turn off the circuit breaker. Contact your agent. Fault, short circuit or fire may occur if you continue to operate the unit under abnormal situation. 	
	<ul style="list-style-type: none"> ● Please contact your agent for maintenance. Improper self maintenance may cause electric shock and fire. 	
	<ul style="list-style-type: none"> ● Please contact your agent if you need to remove and reinstall the unit. Electric shock or fire may occur if you remove and reinstall the unit yourself improperly. 	

PRECAUTIONS DURING OPERATION

 WARNING	<ul style="list-style-type: none"> ● Avoid an extended period of direct air flow for your health. 	
	<ul style="list-style-type: none"> ● Do not insert a finger, a rod or other objects into the air outlet or inlet. As the fan is rotating at a high speed, it will cause injury. Before cleaning, be sure to stop the operation and turn the breaker OFF. 	
	<ul style="list-style-type: none"> ● Do not use any conductor as fuse wire, this could cause fatal accident. 	
	<ul style="list-style-type: none"> ● During thunder storm, disconnect and turn off the circuit breaker. 	

PRECAUTIONS DURING OPERATION

- The product shall be operated under the manufacturer specification and not for any other intended use.



- Do not attempt to operate the unit with wet hands, this could cause fatal accident.

- When operating the unit with burning equipments, regularly ventilate the room to avoid oxygen insufficiency.



- Do not direct the cool air coming out from the air-conditioner panel to face household heating apparatus as this may affect the working of apparatus such as the electric kettle, oven etc.

- Please ensure that outdoor mounting frame is always stable, firm and without defect. If not, the outdoor unit may collapse and cause danger.

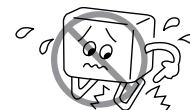

- Do not splash or direct water to the body of the unit when cleaning it as this may cause short circuit.

- Do not use any aerosol or hair sprays near the indoor unit. This chemical can adhere on heat exchanger fin and blocked the evaporation water flow to drain pan. The water will drop on tangential fan and cause water splashing out from indoor unit.



C
A
U
T
I
O
N

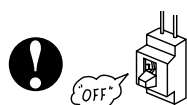

- Please switch off the unit and turn off the circuit breaker during cleaning, the high-speed fan inside the unit may cause danger.

- Turn off the circuit breaker if the unit is not to be operated for a long period.



- Do not climb on the outdoor unit or put objects on it.

- Do not put water container (like vase) on the indoor unit to avoid water dripping into the unit. Dripping water will damage the insulator inside the unit and causes short-circuit.

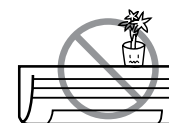

- Do not place plants directly under the air flow as it is bad for the plants.

- When operating the unit with the door and windows opened, (the room humidity is always above 80%) and with the air deflector facing down or moving automatically for a long period of time, water will condense on the air deflector and drips down occasionally. This will wet your furniture. Therefore, do not operate under such condition for a long time.
- If the amount of heat in the room is above the cooling or heating capability of the unit (for example: more people entering the room, using heating equipments and etc.), the preset room temperature cannot be achieved.

- This appliance is not intended for use by young children or infirm persons unless they have been adequately supervised by a responsible person to ensure that they can use the appliance safely.
- Young children should be supervised to ensure that they do not play with the appliance.

NAMES AND FUNCTIONS OF EACH PART

INDOOR UNIT

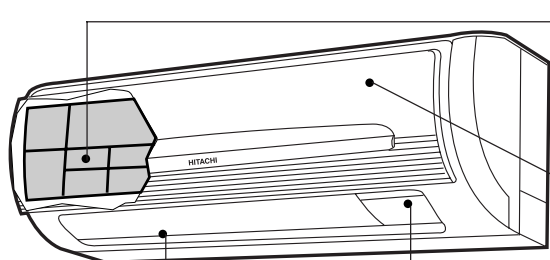

Air filter

To prevent dust from coming into the indoor unit.
(Refer page 31)

Front panel

Indoor unit indicators

Light indicator showing the operating condition.
(Refer page 15)

Horizontal deflector • Vertical deflector (Air Outlet)

(Refer page 26)

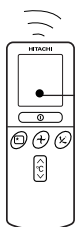

Remote controller

Send out operation signal to the indoor unit. So as to operate the whole unit.
(Refer page 16)

MODEL NAME AND DIMENSIONS

MODEL	WIDTH (mm)	HEIGHT (mm)	DEPTH (mm)
RAK-18NH5/RAK-25NH5/RAK-35NH5	780	280	210

INDOOR UNIT INDICATORS

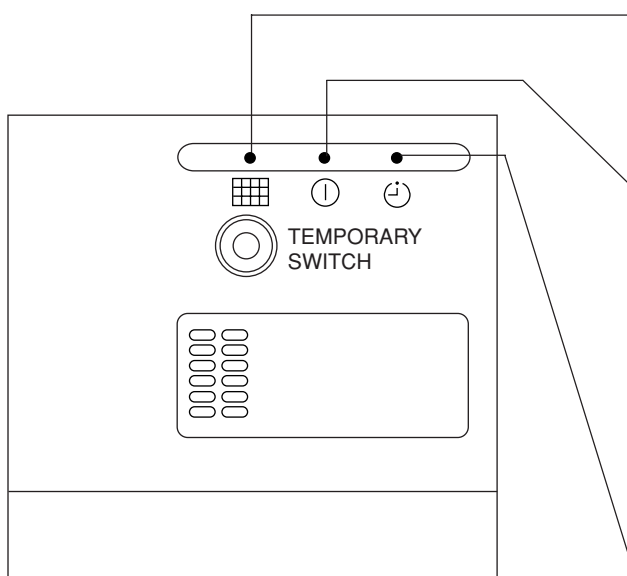

FILTER LAMP

When the device is operated for a total of about 100 hours, the FILTER lamp lights to indicate that it is time to clean the filter.

OPERATION LAMP

This lamp lights during operation.

The OPERATION LAMP flashes in the following cases during heating.

(1) During preheating

For about 2–3 minutes after starting up.

(2) During defrosting

Defrosting will be performed about once every one hour when frost forms on the heat exchanger of the outdoor unit, for 5–10 minutes each time.

TIMER LAMP

This lamp lights when the timer is working.

OPERATION INDICATOR

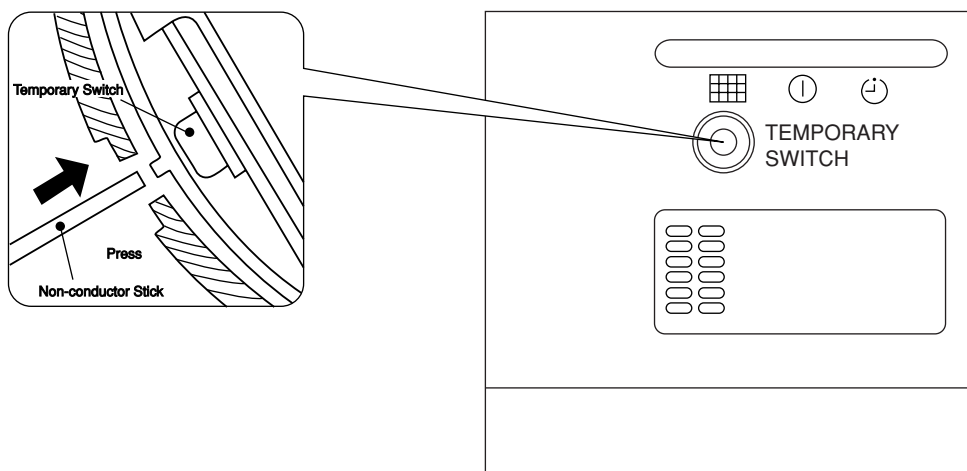

TEMPORARY SWITCH

Use this switch to start and stop when the remote controller does not work. [Use non-conductor stick (example toothpick)]

- By pressing the temporary switch, the operation is done in previously set operation mode.
- When the operation is done using the temporary switch after the power source is turned off and turn on again, the operation is done in automatic mode.

NAMES AND FUNCTIONS OF REMOTE CONTROL UNIT

REMOTE CONTROLLER

- This controls the operation of the indoor unit. The range of control is about 7 meters. If indoor lighting is controlled electronically, the range of control may be shorter.
This unit can be fixed on a wall using the fixture provided. Before fixing it, make sure the indoor unit can be controlled from the remote controller.
- Handle the remote controller with care. Dropping it or getting it wet may compromise its signal transmission capability.
- After new batteries are inserted into the remote controller, the unit will initially require approximately 10 seconds to respond to commands and operate.

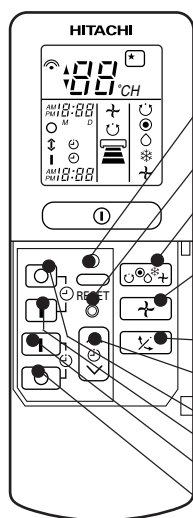
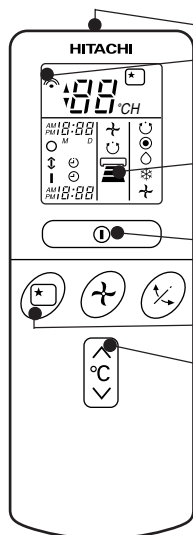

- **Signal emitting window/transmission sign**
Point this window toward the indoor unit when controlling it. The transmission sign blinks when a signal is sent.
- **Display**
This indicates the room temperature selected, current time, timer status, function and intensity of circulation selected.
- **START/STOP button**
Press this button to start operation. Press it again to stop operation.
- **SLEEP button**
Use this button to set the sleep timer.
- **TEMPERATURE buttons**
Use these buttons to raise or lower the temperature setting. (Keep pressed, and the value will change more quickly.)
- **TIME button**
Use this button to set and check the time and date.
- **RESET buttons**
- **FUNCTION selector**
Use this button to select the operating mode. Every time you press it, the mode will change from ☺ (AUTO) to ● (HEAT) to ○ (DEHUMIDIFY) to ❄ (COOL) and to ✈ (FAN) cyclically.
- **FAN SPEED selector**
This determines the fan speed. Every time you press this button, the intensity of circulation will change from ☺ (AUTO) to 🌀 (HI) to 🌀 (MED) to 🌀 (LOW) (This button allows selecting the optimal or preferred fan speed for each operation mode).
- **AUTO SWING button**
Controls the angle of the horizontal air deflector.
- **TIMER control**
Use this button to set the timer.
- **OFF-TIMER button** Select the turn OFF time.
- **ON-TIMER button** Select the turn ON time.
- **RESERVE button** Time setting reservation.
- **CANCEL button** Cancel time reservation.

☺	AUTO
●	HEAT
○	DEHUMIDIFY
❄	COOL
✈	FAN
🌀	FAN SPEED LOW MED HI
★	SLEEPING
○	STOP (CANCEL)
I	START (RESERVE)
①	START/STOP
⌚	TIME
⌚	TIMER SET
⌚	TIMER SELECTOR ON TIMER OFF TIMER
✂	AUTO SWING

Precautions for Use

- Do not put the remote controller in the following places.
 - Under direct sunlight.
 - In the vicinity of a heater.
- Handle the remote controller carefully. Do not drop it on the floor, and protect it from water.
- Once the outdoor unit stops, it will not restart for about 3 minutes (unless you turn the power switch off and on or unplug the power cord and plug it in again).
This is to protect the device and does not indicate a failure.
- If you press the FUNCTION selector button during operation, the device may stop for about 3 minutes for protection.

VARIOUS FUNCTIONS

■ Auto Restart Control

- If there is a power failure, operation will be automatically restarted when the power is resumed with previous operation mode and airflow direction.
(As the operation is not stopped by remote controller.)
- If you intend not to continue the operation when the power is resumed, switch off the power supply.
When you switch on the circuit breaker, the operation will be automatically restarted with previous operation mode and airflow direction.

Note: 1. If you do not require Auto Restart Control, please consult your sales agent or OFF by remote control.
2. Auto Restart Control is not available when Timer or Sleep Timer mode is set.

AUTOMATIC OPERATION

The device will automatically determine the mode of operation, HEAT, COOL or DEHUMIDIFY depending on the current room temperature. The selected mode of operation will change when the room temperature varies. However the mode of operation will not change when indoor unit connected to multi type outdoor unit.

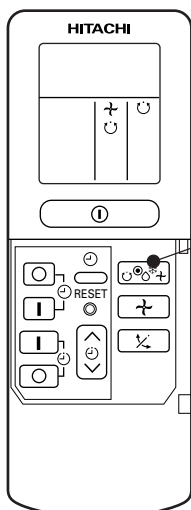

Press the FUNCTION selector so that the display indicates the  (AUTO) mode of operation.

- When AUTO has been selected, the device will automatically determine the mode of operation, HEAT, COOL or DEHUMIDIFY depending on the current room temperature. However the mode of operation will not change when indoor unit connected to multi type outdoor unit.
- If the mode automatically selected by the unit is not satisfactory, manually change the mode setting (heat, dehumidify, cool or fan).

**START
STOP**

Press the  (START/STOP) button.
Operation starts with a beep.
Press the button again to stop operation.

- As the settings are stored in memory in the remote controller, you only have to press the  (START/STOP) button next time.

You can raise or lower the temperature setting as necessary by maximum of 3°C.



Press the temperature button and the temperature setting will change by 1°C each time.

- The preset temperature and the actual room temperature may vary somewhat depending on conditions.
- The display does not indicate the preset temperature in the AUTO mode.
If you change the setting, the indoor unit will produce a beep.

Press the  (FAN SPEED) button, AUTO and LOW is available.

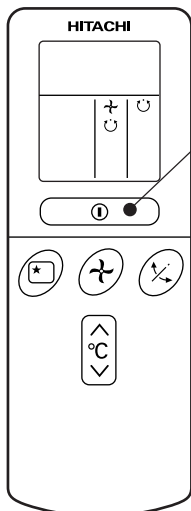

HEATING OPERATION

- Use the device for heating when the outdoor temperature is under 21°C.
When it is too warm (over 21°C), the heating function may not work in order to protect the device.
- In order to keep reliability of the device, please use this device above -15°C of the outdoor temperature.

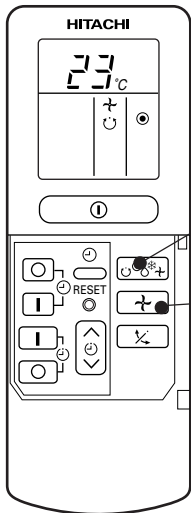

1

Press the FUNCTION selector so that the display indicates ● (HEAT).

Set the desired FAN SPEED with the ↻ (FAN SPEED) button (the display indicates the setting).

↻ (AUTO): The fan speed is HI at first and varies to MED or LOW automatically when the preset temperature has been reached.

↻ (HI) : Economical as the room will become warm quickly.
But you may feel a chill at the beginning.

↻ (MED) : Fan speed slow.

↻ (LOW) : Fan speed slower.

2

Set the desired room temperature with the TEMPERATURE buttons (the display indicates the setting).

3

The temperature setting and the actual room temperature may vary somewhat depending on conditions.

**START
STOP**

Press the ⏻ (START/STOP) button. Heating operation starts with a beep. Press the button again to stop operation.

- As the settings are stored in memory in the remote controller, you only have to press the ⏻ (START/STOP) button next time.

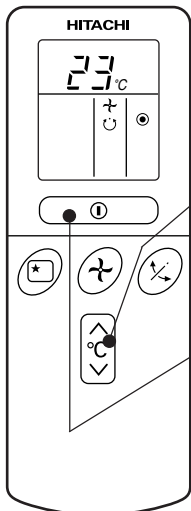

DEHUMIDIFYING OPERATION

Use the device for dehumidifying when the room temperature is over 16°C.
When it is under 15°C, the dehumidifying function will not work.

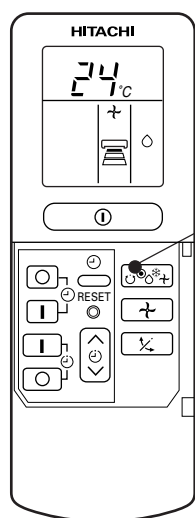

1

Press the FUNCTION selector so that the display indicates ◊ (DEHUMIDIFY).
The FAN SPEED is set at LOW automatically.
The FAN SPEED button does not work.

2

Set the desired room temperature with the TEMPERATURE button (the display indicates the setting).

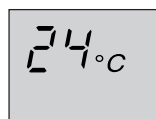

The range of 20-26°C is recommended as the room temperature for dehumidifying.

**START
STOP**

Press the Ⓜ (START/STOP) button. Dehumidifying operation starts with a beep. Press the button again to stop operation.

- As the settings are stored in memory in the remote controller, you only have to press the Ⓜ (START/STOP) button next time.

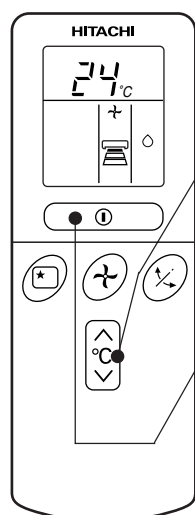

■ Dehumidifying Function

When the room temperature is higher than the temperature setting: The device will dehumidify the room, reducing the room temperature to the preset level.

When the room temperature is lower than the temperature setting: Dehumidifying will be performed at the temperature setting slightly lower than the current room temperature, regardless of the temperature setting. The function will stop (the indoor unit will stop emitting air) as soon as the room temperature becomes lower than the setting temperature.

COOLING OPERATION

Use the device for cooling when the outdoor temperature is $-10 \sim 43^{\circ}\text{C}$.
If in doors humidity is very high (80%), some dew may form on the air outlet grille of the indoor unit.

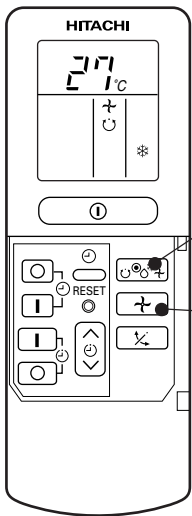

1

Press the FUNCTION selector so that the display indicates * (COOL).

Set the desired FAN SPEED with the \updownarrow (FAN SPEED) button (the display indicates the setting).

\updownarrow (AUTO): The FAN SPEED is HI at first and varies to MED or LOW automatically when the preset temperature has been reached.

 (HI) : Economical as the room will become cool quickly.

 (MED) : Fan speed slow.

 (LOW) : Fan speed slower.

2

Set the desired room temperature with the TEMPERATURE button (the display indicates the setting).

The temperature setting and the actual room temperature may vary some how depending on conditions.

3

Press the ON (START/STOP) button. Cooling operation starts with a beep. Press the button again to stop operation. The cooling function does not start if the temperature setting is higher than the current room temperature (even though the ON (OPERATION) lamp lights). The cooling function will start as soon as you set the temperature below the current room temperature.

START
STOP

■ As the settings are stored in memory in the remote controller, you only have to press the ON (START/STOP) button next time.

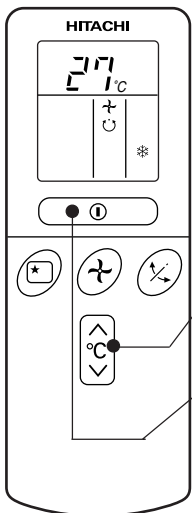

FAN OPERATION

You can use the device simply as an air circulator. Use this function to dry the interior of the indoor unit at the end of summer.

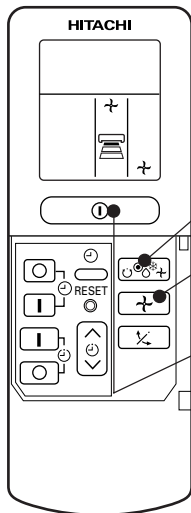

1

Press the FUNCTION selector so that the display indicates (FAN).

2

Press the (FAN SPEED) button.

**START
STOP**

Press the (START/STOP) button. Fan operation starts with a beep. Press the button again to stop operation.

FAN SPEED (AUTO)

..... When the AUTO fan speed mode is set in the cooling/heating operation:

For the heating operation	<ul style="list-style-type: none"> ● The fan speed will automatically change according to the temperature of discharged air. ● When the difference of room temperature and setting temperature is large, fan starts to run at HI speed. ● When the room temperature reaches setting temperature, fan speed changes to LOW automatically.
For the cooling operation	<ul style="list-style-type: none"> ● When the difference of room temperature and setting temperature is large, fan starts to run at HI speed. ● After room temperature reaches the preset temperature, the cooling operation, which changes the fan speed and room temperature to obtain optimum conditions for natural healthful cooling will be performed.

HOW TO SET THE TIMER

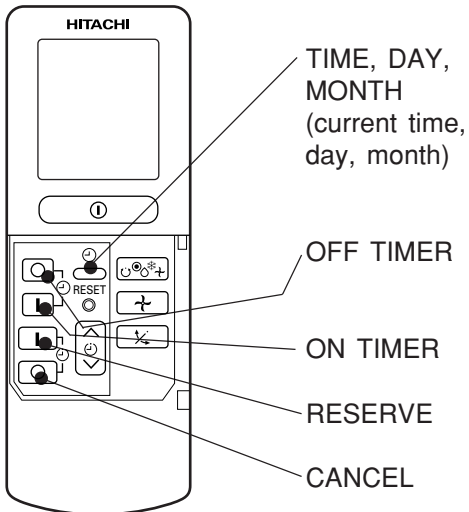

Time, Day, Month

After you change the batteries;

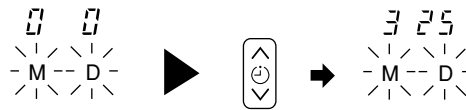

1 Set the current month and day with the TIMER control button.

OFF-Timer

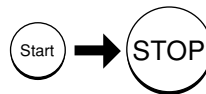

You can set the device to turn off at the present time.

1 Press the (OFF-TIMER) button. The (OFF) mark blinks on the display.

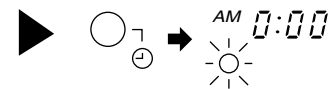

ON-Timer

- The device will turn on at the designated times.

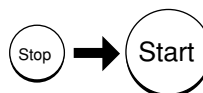

1 Press the (ON-TIMER) button the (ON) mark blinks on the display.

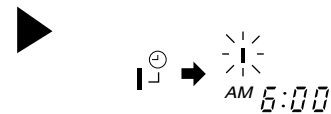

ON/OFF-Timer

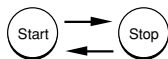

- The device will turn on (off) and off (on) at the designated times.
- The switching occurs first at the preset time that comes earlier.
- The arrow mark appearing on the display indicates the sequence of switching operations.

1 Press the (ON-OFF) button so that the (OFF) mark blinks.

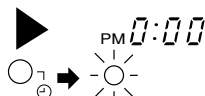

2 Set the turn-off time with the TIMER control button. Press the (RESERVE) button.

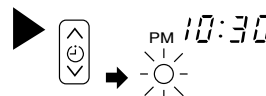

3 Press the (ON-TIMER) button so that the (OFF) mark lights and the (ON) mark blinks.

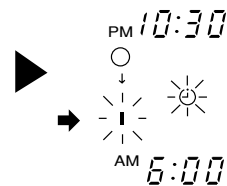

How to Cancel Reservation

Point the signal window of the remote controller toward the indoor unit, and press the (CANCEL) button.

The (RESERVED) sign goes out with a beep and the (TIMER) lamp turns off on the indoor unit.

NOTE

You can set only one of the OFF-timer, ON-timer and ON/OFF-timer.

2 Press the  (TIME) button.



3 Set the current time with the TIMER control button.

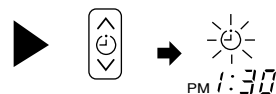

4 Press the  (TIME) button again. The time indication starts lighting instead of flashing.

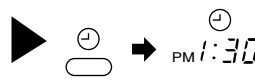



- The time indication will disappear automatically in 10 second.
- To check the current time setting, press the  (TIME) button twice.

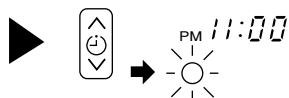

The setting of the current time is now complete.

Example: The current time is 1:30 p.m.

2 Set the turn-off time with the TIMER control button.



3 Point the signal window of the remote controller toward the indoor unit, and press the  (RESERVE) button.

The  (OFF) mark starts lighting instead of flashing and the sign  (RESERVED) lights. A beep occurs and the  (TIMER) lamp lights on the indoor unit.

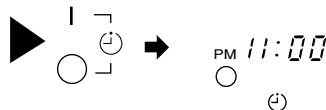



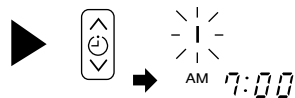

Example: The device will turn off at 11:00p.m.

The setting of turn-off time is now complete.

2 Set the turn-on time with the TIMER control button.



3 Point the signal window of the remote controller toward the indoor unit, and press the  (RESERVE) button.

The  (ON) mark starts lighting instead of flashing and the  (RESERVED) sign lights. A beep occurs and the  (TIMER) lamp lights on the indoor unit.

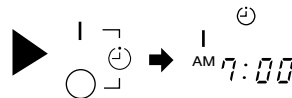

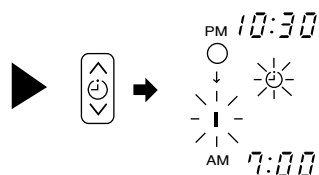

Example:
The device will turn on at 7:00 a.m.
The setting of the turn-on time is now complete.

4 Set the turn-on time with the TIMER control button.



5 Point the signal window of the remote controller toward the indoor unit, and press the  (RESERVE) button.

The  (ON) mark starts lighting instead of flashing and the  (RESERVED) sign lights. A beep occurs and the  (TIMER) lamp lights on the indoor unit.

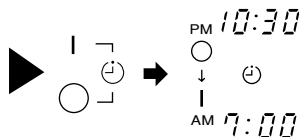

Example:
The device will turn off at 10:30 p.m. and it will be turned on at 7:00 a.m.
The settings of the turn-on/off times are now complete.

- The timer may be used in three ways: off-timer, on-timer, and ON/OFF (OFF/ON)-timer. Set the current time at first because it serves as a reference.
- As the time settings are stored in memory in the remote controller, you only have to press the  (RESERVE) button in order to use the same settings next time.

HOW TO SET THE SLEEP TIMER

Set the current time at first if it is not set before (see the pages for setting the current time). Press the  (SLEEP) button, and the display changes as shown below.

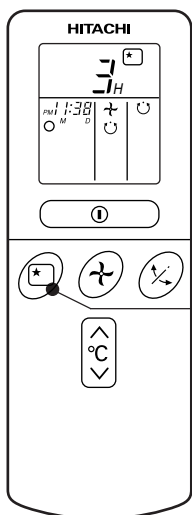

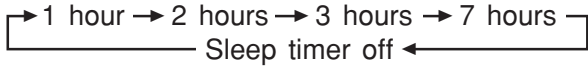
Mode	Indication
Sleep timer	

Sleep Timer: The device will continue working for the designated number of hours and then turn off. Point the signal window of the remote controller toward the indoor unit, and press the SLEEP button. The timer information will be displayed on the remote controller. The TIMER lamp lights with a beep from the indoor unit. When the sleep timer has been set, the display indicates the turn-off time.

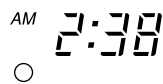

Example: If you set 3 hours sleep time at 11:38 p.m., the turn-off time is 2:38 a.m.

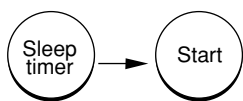

The device will be turned off by the sleep timer and turned on by on-timer.

1 Set the ON-timer.

2 Press the  (SLEEP) button and set the sleep timer.

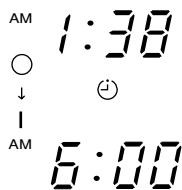
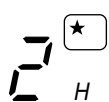

For heating:

In this case, the device will turn off in 2 hours (at 1:38 a.m.) and turn on early so that the preset temperature will be almost reached at 6:00 next morning.

How to Cancel Reservation

Point the signal window of the remote controller toward the indoor unit, and press the  (CANCEL) button.

The  (RESERVED) sign goes out with a beep and the  (TIMER) lamp turns off on the indoor unit.

Explanation of the sleep timer

The device will control the FAN SPEED and room temperature automatically so as to be quiet and good for people's health.

NOTE

- If date or current time is not set, sleep timer can not be set.
- If you set the sleep timer after the off-, on/off- or off/on-timer has been set, the sleep timer becomes effective instead of the off-, on/off- or off/on-timer set earlier.
- You can not set other timer during sleep timer operation.
- After sleep timer time is up and when press sleep button again, the sleep timer will be set as last setting.
- Sleep timer effective only once.

ADJUSTING THE AIR DEFLECTOR

- 1** Adjustment of the conditioned air in the upward and downward directions.

The horizontal air deflector is automatically set to the proper angle suitable for each operation. The deflector can be swung up and down continuously and also set to the desired angle using the “ (AUTO SWING)” button.

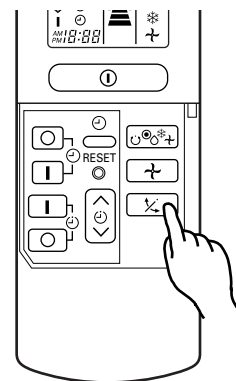

- If the “ (AUTO SWING)” button is pressed once, the horizontal air deflector swings up and down. If the button is pressed again, the deflector stops in its current position. Several seconds (about 6 seconds) may be required before the deflector starts to move.
- Use the horizontal air deflector within the adjusting range shown on the right.
- When the operation is stopped, the horizontal air deflector moves and stops at the position where the air outlet closes.

CAUTION

- In “Cooling” operation, do not keep the horizontal air deflector swinging for a long time. Some dew may form on the horizontal air deflector and dew may drop.

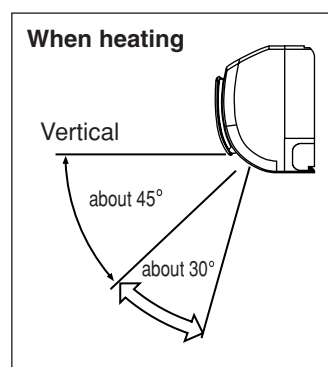
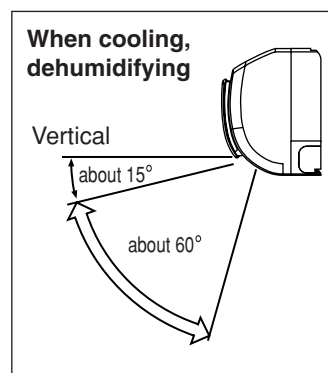

- 2** Adjustment of the conditioned air to the left and right.

Hold the vertical air deflector as shown in the figure and adjust the conditioned air to the left and right.

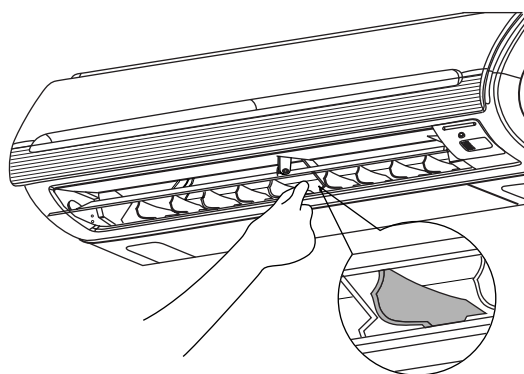

HOW TO EXCHANGE THE BATTERIES IN THE REMOTE CONTROLLER

1 Remove the cover as shown in the figure and take out the old batteries.



2 Install the new batteries.
The direction of the batteries should match the marks in the case.

⚠ CAUTION

1. Do not use new and old batteries, or different kinds of batteries together.
2. Take out the batteries when you do not use the remote controller for 2 or 3 months.

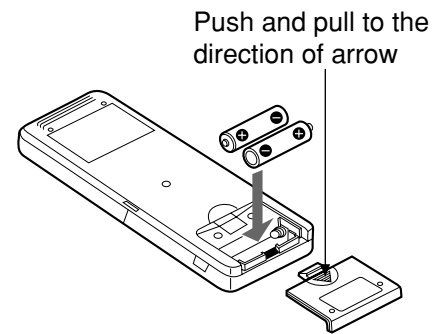

THE IDEAL WAYS OF OPERATION

Suitable Room Temperature

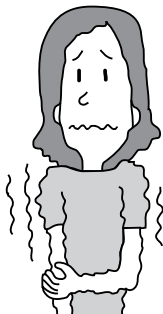

⚠ Warning
Freezing temperature is bad for health and a waste of electric power.

Install curtain or blinds

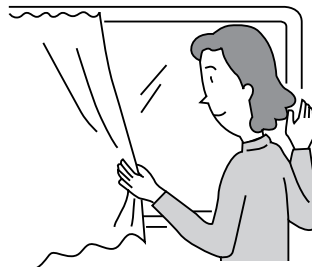

It is possible to reduce heat entering the room through windows.

Ventilation

⚠ Caution
Do not close the room for a long period of time. Occasionally open the door and windows to allow the entrance of fresh air.



Effective Usage Of Timer

At night, please use the “OFF or ON timer operation mode”, together with your wake up time in the morning. This will enable you to enjoy a comfortable room temperature. Please use the timer effectively.

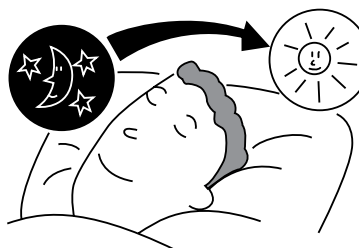

Do Not Forget To Clean The Air Filter

Dusty air filter will reduce the air volume and the cooling efficiency. To prevent from wasting electric energy, please clean the filter every 2 weeks.

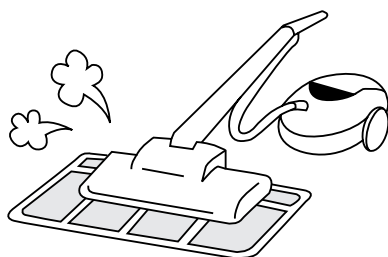

Please Adjust Suitable Temperature For Baby And Children

Please pay attention to the room temperature and air flow direction when operating the unit for baby, children and old folks who have difficulty in movement.

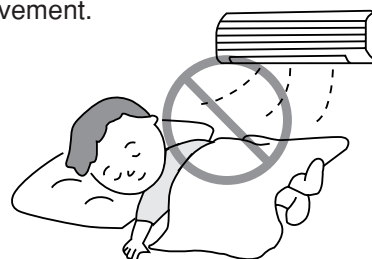

FOR USER'S INFORMATION

The Air Conditioner And The Heat Source In The Room

⚠ Caution

If the amount of heat in the room is above the cooling capability of the air conditioner (for example: more people entering the room, using heating equipments and etc.), the preset room temperature cannot be achieved.

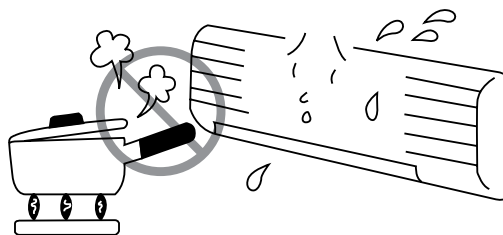

Not Operating For A Long Time

When the indoor unit is not to be used for a long period of time, please switch off the power from the mains. If the power from mains remains "ON", the indoor unit still consumes about 8W in the operation control circuit even if it is in "OFF" mode.

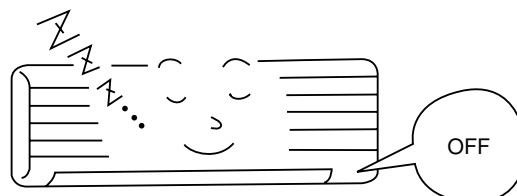

When Lightning Occurs

⚠ Warning

To protect the whole unit during lightning, please stop operating the unit and remove the plug from the socket.

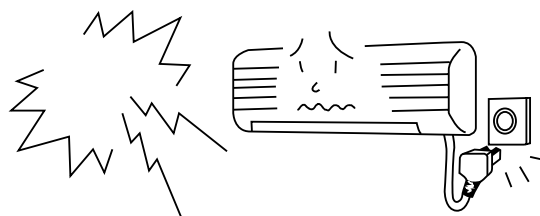

Interference From Electrical Products

⚠ Caution

To avoid noise interference, please place the indoor unit and its remote controller at least 1m away from electrical products.

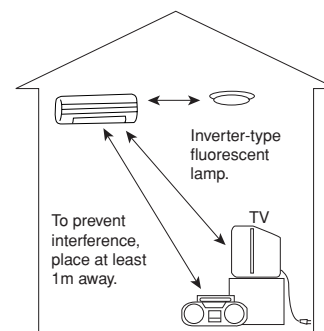

ATTACHING THE AIR CLEANSING AND DEODORIZING FILTERS

⚠ CAUTION

Cleaning and maintenance must be carried out only by qualified service personal. Before cleaning, stop operation and switch off the power supply.

1 Open the front panel.

- Pull up the front panel by holding it at both sides with both hands.

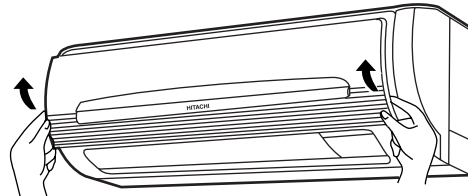

2 Remove the filter.

- Push upward to release the claws and pull out the filter.

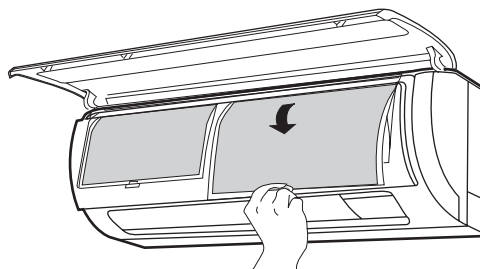

3 Attaching the air cleansing and deodorizing filters to the filter.

- Attach the air cleansing and deodorizing filters to the frame by gently compress its both sides and release after insertion into filter frame.

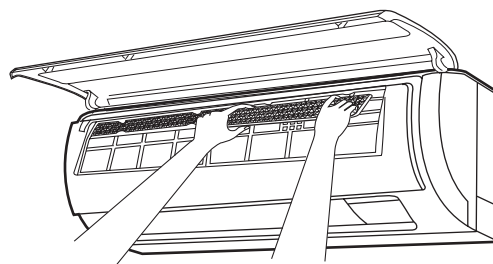

⚠ CAUTION

Do not bend the air cleansing and deodorizing filter as it may cause damage to the structure.

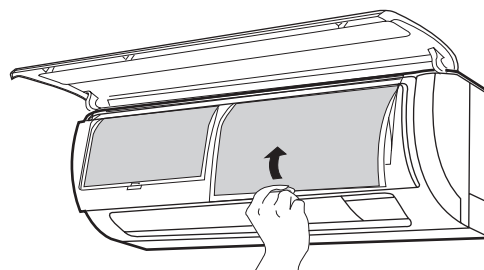

4 Attach the filters.

- Attach the filters by ensuring that the surface written "FRONT" is facing front.
- After attaching the filters, push the front panel at three arrow portion as shown in figure and close it.

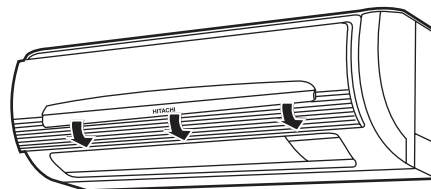

NOTE

- In case of removing the air cleansing and deodorizing filters, please follow the above procedures.
- The cooling capacity is slightly weakened and the cooling speed becomes slower when the air cleansing and deodorizing filters are used. So, set the fan speed to "HIGH" when using it in this condition.
- Air cleansing and deodorizing filters are washable and reusable up to 20 times by using vacuum cleaner or water rinse under running tap water. Type number for this air cleansing filter is <SPX-CFH11>. Please use this number for ordering when you want to renew it.
- Do not operate the air conditioner without filter. Dust may enter the air conditioner and fault may occur.

MAINTENANCE

▲ CAUTION

Cleaning and maintenance must be carried out only by qualified service personal. Before cleaning, stop operation and switch off the power supply.

1. AIR FILTER

Clean the air filter, as it removes dust inside the room. In case the air filter is full of dust, the air flow will decrease and the cooling capacity will be reduced. Further, noise may occur. Be sure to clean the filter following the procedure below.

PROCEDURE

- 1 Open the front panel and remove the filter
 - Gently lift and remove the air cleansing and deodorizing filter from the air filter frame.

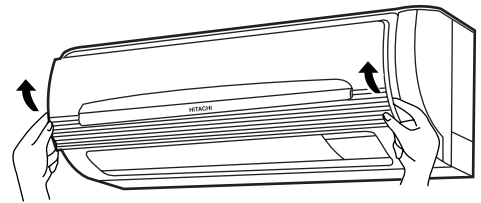

- 2 Vacuum dust from the air filter and air cleansing and deodorizing filter using vacuum cleaner. If there is too much dust, rinse under running tap water and gently brush it with soft bristle brush. Allow filters to dry in shade.

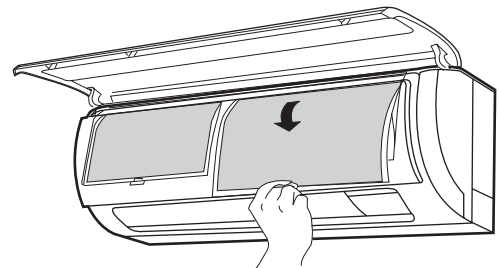
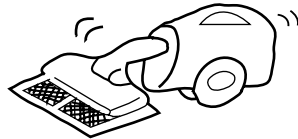

- 3
 - Re-insert the air cleansing and deodorizing filter to the filter frame. Set the filter with "FRONT" mark facing front, and slot them into the original state.
 - After attaching the filters, push the front panel at three arrow portions as shown in figure and close it.

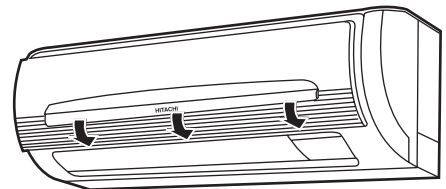

NOTE:

- Air cleansing and deodorizing filter should be cleaned every month or sooner if noticeable loading occurs. When used overtime, it may loose its deodorizing function. For maximum performance, it is recommended to replace it every 3-6 months depending on application requirements.

▲ CAUTION

- Do not wash with hot water at more than 40°C. The filter may shrink.
- When washing it, shake off moisture completely and dry it in the shade; do not expose it directly to the sun. The filter may shrink.
- Do not use detergent on the air cleansing and deodorizing filter as some detergent may deteriorate the filter electrostatic performance.

2. Washable Front Panel

- Remove the front panel and wash with clean water.
Wash it with a soft sponge.
After using neutral detergent, wash thoroughly with clean water.
- When front panel is not removed, wipe it with a soft dry cloth. Wipe the remote controller thoroughly with a soft dry cloth.
- Wipe the water thoroughly.
If water remains at indicators or signal receiver of indoor unit, it causes trouble.

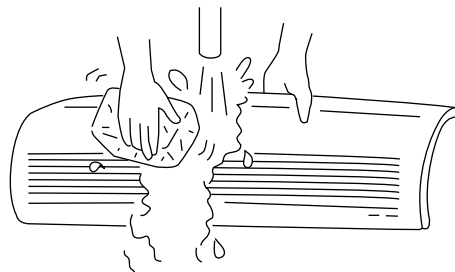

Method of removing the front panel.
Be sure to hold the front panel with both hands to detach and attach it.

Removing the Front Panel

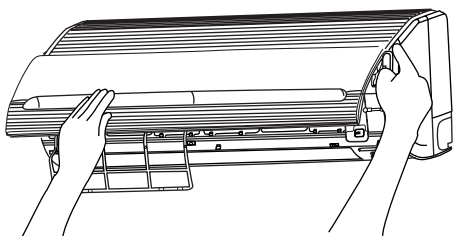

- When the front panel is fully opened with both hands, push the right arm to the inside to release it, and while closing the front panel slightly, put it out forward.

Attaching the Front Panel

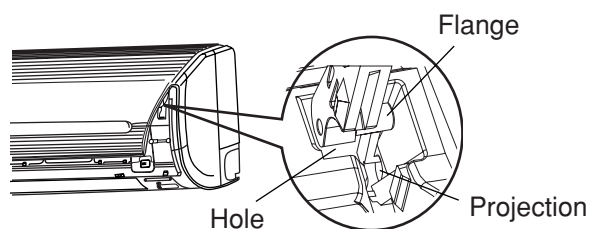

- Move the projections of the left and right arms into the **Flanges** in the unit and securely insert them into the holes.

CAUTION

- Do not splash or direct water to the body of the unit when cleaning it as this may cause short circuit.
- Never use hot water (above 40°C), benzine, gasoline, acid, thinner or a brush, because they will damage the plastic surface and the coating.



▲ CAUTION

Cleaning and maintenance must be carried out only by qualified service personal. Before cleaning, stop operation and switch off the power supply.

3. MAINTENANCE AT BEGINNING OF LONG OFF PERIOD

- Run the unit by setting the operation mode to ❄️ (COOL), the temperature to 32°C and the fan speed to HI for about half a day on a fine day, and dry the whole of the unit.
- Switch off the power plug.

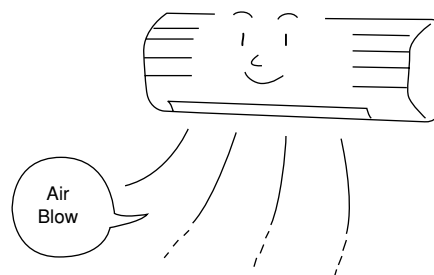

REGULAR INSPECTION

PLEASE CHECK THE FOLLOWING POINTS BY QUALIFIED SERVICE PERSONAL EITHER EVERY HALF YEARLY OR YEARLY. CONTACT YOUR SALES AGENT OR SERVICE SHOP.

1		Is the earth line disconnected or broken?
2		Is the mounting frame seriously affected by rust and is the outdoor unit tilted or unstable?
3		Is the plug of power line firmly plugged into the socket? (Please ensure no loose contact between them).

AFTER SALE SERVICE AND WARRANTY

WHEN ASKING FOR SERVICE, CHECK THE FOLLOWING POINTS.

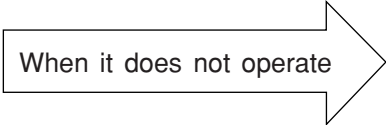
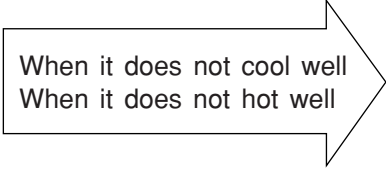
CONDITION	CHECK THE FOLLOWING POINTS
 <p>When it does not operate</p>	<ul style="list-style-type: none">● Is the fuse all right?● Is the voltage extremely high or low?● Is the circuit breaker "ON"?
 <p>When it does not cool well When it does not hot well</p>	<ul style="list-style-type: none">● Was the air filter cleaned?● Does sunlight fall directly on the outdoor unit?● Is the air flow of the outdoor unit obstructed?● Are the doors or windows opened, or is there any source of heat in the room?● Is the set temperature suitable?



Notes

- In quiet operation or stopping the operation, the following phenomena may occasionally occur, but they are not abnormal for the operation.
 - (1) Slight flowing noise of refrigerant in the refrigerating cycle.
 - (2) Slight rubbing noise from the fan casing which is cooled and then gradually warmed as operation stops.
- The odor will possibly be emitted from the room air conditioner because the various odor, emitted by smoke, foodstuffs, cosmetics and so on, sticks to it. So the air filter and the evaporator regularly must be cleaned to reduce the odor.

- Please contact your sales agent immediately if the air conditioner still fails to operate normally after the above inspections. Inform your agent of the model of your unit, production number, date of installation. Please also inform him regarding the fault.
- Power supply shall be connected at the rated voltage, otherwise the unit will be broken or could not reach the specified capacity.

CONSTRUCTION AND DIMENSIONAL DIAGRAM

MODEL RAK-18NH5, RAK-25NH5, RAK-35NH5

INDOOR UNIT

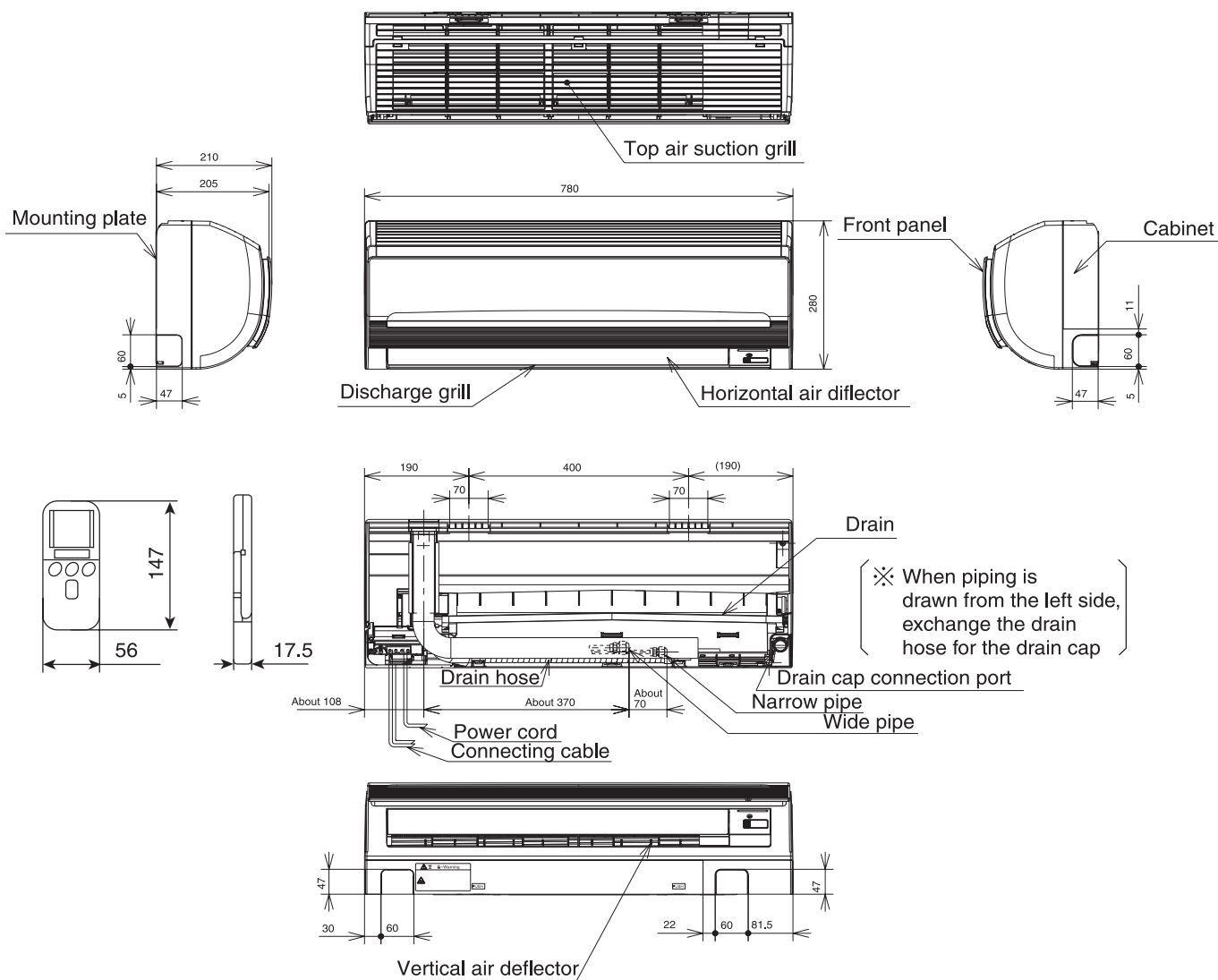

MAIN PARTS COMPONENT

THERMOSTAT

Thermostat Specifications

MODEL			RAK-18NH5, RAK-25NH5, RAK-35NH5	
THERMOSTAT MODEL			IC	
OPERATION MODE			COOL	HEAT
TEMPERATURE °C (°F)	INDICATION 16	ON	16.7 (62.1)	20.0 (68.0)
		OFF	16.0 (60.8)	20.7 (69.3)
	INDICATION 24	ON	24.7 (76.5)	28.0 (82.4)
		OFF	24.0 (75.2)	28.7 (83.7)
	INDICATION 32	ON	32.7 (90.9)	36.0 (96.8)
		OFF	32.0 (89.6)	36.7 (98.1)

FAN MOTOR

Fan Motor Specifications

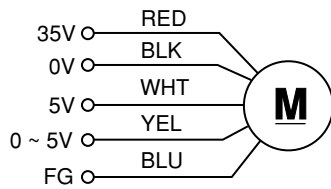
MODEL	RAK-18NH5, RAK-25NH5, RAK-35NH5
POWER SOURCE	DC: 5V, 35V
OUTPUT	25W
CONNECTION	 <p>(Control circuit built in)</p>

BLU : BLUE

YEL : YELLOW

BRN : BROWN

WHT : WHITE

GRY : GRAY

ORN : ORANGE

GRN : GREEN

RED : RED

BLK : BLACK

PNK : PINK

VIO : VIOLET

WIRING DIAGRAM

MODEL RAK-18NH5, RAK-25NH5, RAK-35NH5

INDOOR UNIT

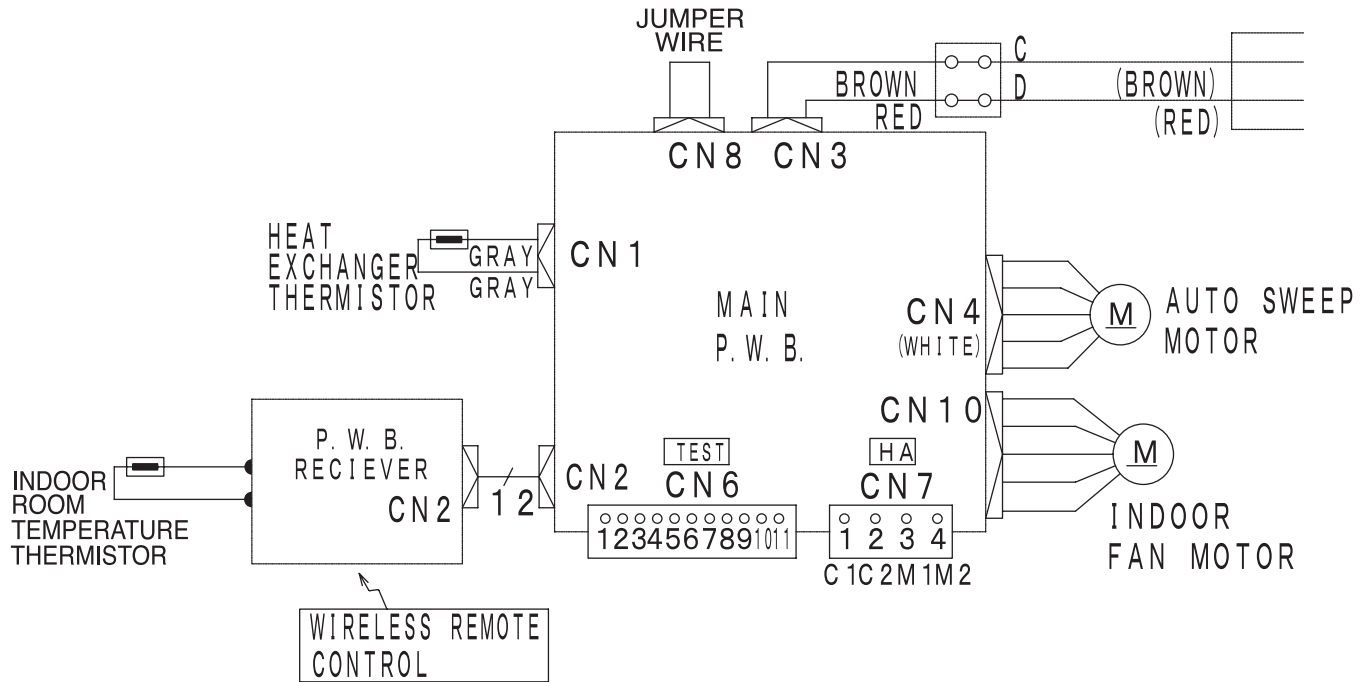

CIRCUIT DIAGRAM

Remote Control

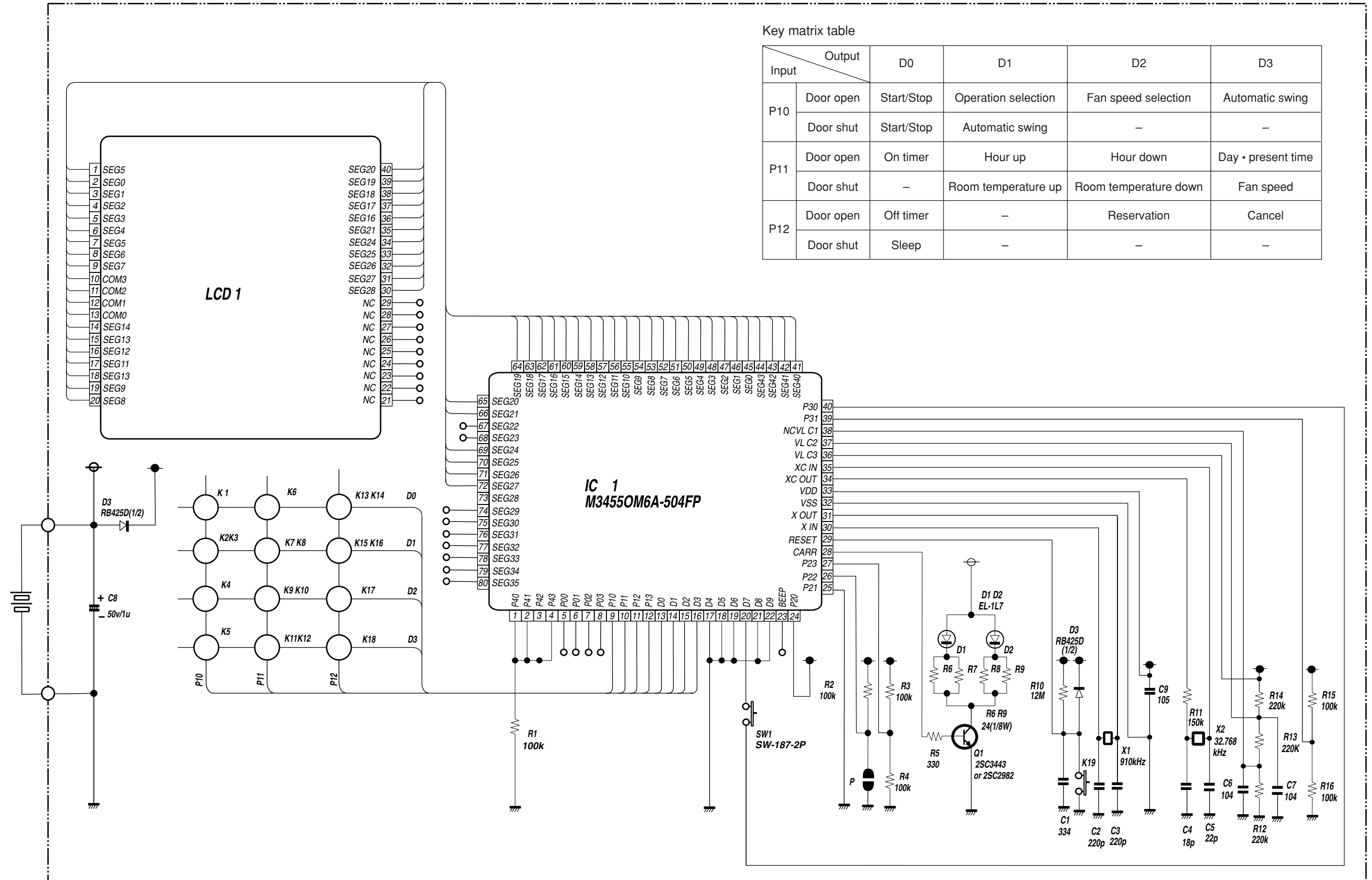

Key matrix table

Input \ Output		D0	D1	D2	D3
		D0	D1	D2	D3
P10	Door open	Start/Stop	Operation selection	Fan speed selection	Automatic swing
	Door shut	Start/Stop	Automatic swing	-	-
P11	Door open	On timer	Hour up	Hour down	Day · present time
	Door shut	-	Room temperature up	Room temperature down	Fan speed
P12	Door open	Off timer	-	Reservation	Cancel
	Door shut	Sleep	-	-	-

CIRCUIT DIAGRAM

MODEL RAK-18NH5, RAK-25NH5, RAK-35NH5

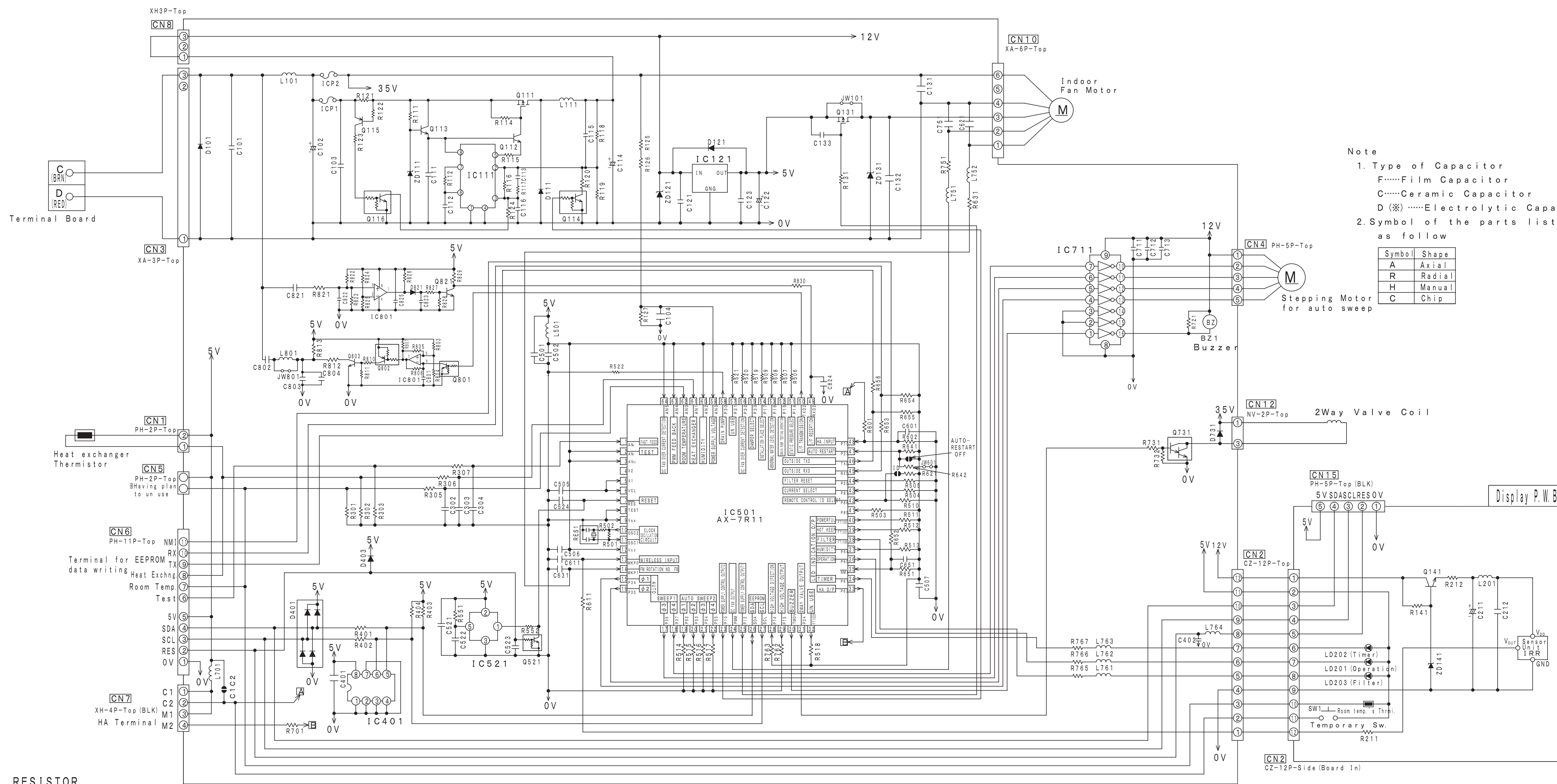

Note
 1. Type of Capacitor
 F.....Film Capacitor
 C.....Ceramic Capacitor
 D (X).....Electrolytic Capacitor
 2. Symbol of the parts list is as follow

Symbol	Shape
A	Axial
R	Radial
H	Manual
C	Chip

RESISTOR

Circuit's Symbol	Numerical Value	Power	Drawing's part's No.
R111	2.7K	±5% 1/16W 014 C	
R112	30K	±5% 1/16W 029 C	
R114	750	±5% 1/8W 010 C	
R115	560	±5% 1/8W 011 C	
R116	-	-	
R117	68K	±5% 1/16W 024 C	
R118	75K	±2% 1/16W 021 C	
R119	6.8k	±2% 1/16W 022 C	
R121	0.56	±5% 1/4W 008 C	
R122	100	±5% 1/16W 042 C	
R123	33K	±5% 1/16W 043 C	
R124	100	±5% 1/16W 042 C	
R125	30K	±5% 1/16W 029 C	
R126	30K	±5% 1/16W 029 C	
R127	5.1K	±5% 1/16W 040 C	
R131	5.1K	±5% 1/16W 020 C	
R141	2.7K	±5% 1/16W 010 C	
R211	1K	±5% 1/16W 033 C	
R212	4.7	±5% 1/16W 016 C	
R301	12.7K	±1% 1/16W 018 C	
R302	12.7K	±1% 1/16W 018 C	
R303	10K	±5% 1/16W 030 C	
R321	10K	±5% 1/16W 030 C	

Circuit's Symbol	Numerical Value	Power	Drawing's part's No.
R305	1K	±5% 1/16W 033 C	
R306	1K	±5% 1/16W 033 C	
R307	1K	±5% 1/16W 033 C	
R308	390	±5% 1/16W 027 C	
R309	390	±5% 1/16W 027 C	
R310	5.1K	±5% 1/16W 040 C	
R311	5.1K	±5% 1/16W 040 C	
R312	1M	±5% 1/16W 041 C	
R313	10K	±5% 1/16W 030 C	
R314	10K	±5% 1/16W 030 C	
R315	10K	±5% 1/16W 030 C	
R316	10K	±5% 1/16W 030 C	
R317	10K	±5% 1/16W 030 C	
R318	10K	±5% 1/16W 030 C	
R319	10K	±5% 1/16W 030 C	
R320	10K	±5% 1/16W 030 C	
R321	10K	±5% 1/16W 030 C	
R322	10K	±5% 1/16W 030 C	
R323	10K	±5% 1/16W 030 C	
R324	10K	±5% 1/16W 030 C	
R325	10K	±5% 1/16W 030 C	
R326	10K	±5% 1/16W 030 C	
R327	10K	±5% 1/16W 030 C	
R328	10K	±5% 1/16W 030 C	
R329	10K	±5% 1/16W 030 C	
R330	10K	±5% 1/16W 030 C	

Circuit's Symbol	Numerical Value	Power	Drawing's part's No.
R522	10K	±5% 1/16W 030 C	
R751	2.7K	±5% 1/16W 024 C	
R762	10K	±5% 1/16W 009 A	
R763	10K	±5% 1/16W 009 A	
R764	390	±5% 1/16W 027 C	
R765	390	±5% 1/16W 027 C	
R766	390	±5% 1/16W 026 C	
R767	390	±5% 1/16W 027 C	
R804	120K	±5% 1/8W 039 C	
R805	120K	±5% 1/16W 031 C	
R806	120K	±5% 1/16W 031 C	
R807	4.3K	±5% 1/16W 038 C	
R810	680	±5% 1/16W 028 C	
R811	2K	±5% 1/16W 035 C	
R812	39	±5% 1/8W 013 C	
R813	39	±5% 1/8W 013 C	
R821	1K	±5% 1/16W 033 C	
R822	10K	±1% 1/16W 017 C	
R823	10K	±1% 1/16W 017 C	
R824	8.25K	±1% 1/16W 019 C	
R825	10K	±1% 1/16W 017 C	
R826	1K	±5% 1/16W 033 C	
R827	3K	±5% 1/16W 037 C	
R828	10K	±5% 1/16W 030 C	
R829	5.1K	±5% 1/16W 040 C	
R830	1K	±5% 1/16W 006 A	

Circuit's Symbol	Numerical Value	Power	Drawing's part's No.
C101	0.22μ	50V F 082 R	
C102	330μ	50V EP 065 R	
C103	470p	630V C 052 C	
C104	0.1μ	25V C 045 C	
C111	2.2μ	10V C 058 C	
C112	1000P	50V C 047 C	
C113	0.047μ	25V C 056 C	
C114	220μ	25V EP 066 R	
C115	-	-	
C116	-	-	
C121	0.1μ	25V C 045 C	
C122	100μ	10V EP 068 R	
C123	0.1μ	25V C 045 C	
C131	0.22μ	25V C 045 C	
C132	0.1μ	25V C 045 C	
C133	0.1μ	25V C 045 C	
C211	47μ	16V EP 069 R	
C212	1μ	16V C 049 C	
C302	0.1μ	25V C 045 C	
C303	0.1μ	25V C 045 C	
C304	0.1μ	25V C 045 C	
C401	0.1μ	25V C 045 C	
C402	-	-	

Circuit's Symbol	Model	Drawing's part's No.
Q111	2SJ518	0.76 C
Q112	2SC5209H	0.74 C
Q113	2SC5209H	0.74 C
Q114	RN1102	0.78 C
Q115	2SA1162Y	0.79 C
Q116	RN1102	0.78 C
Q131	-	-
Q141	2SC2462LC	0.71 C
Q521	RN1102	0.78 C
Q731	-	-

Circuit's Symbol	Model	Drawing's part's No.
IC501	AX-7R11	0.85 C
IC801	2SC4738GR	0.73 C
IC802	2SC4738GR	0.73 C
IC803	2SC4738GR	0.73 C
IC804	2SC4738GR	0.73 C
IC805	2SC4738GR	0.73 C
IC806	2SC4738GR	0.73 C
IC807	2SC4738GR	0.73 C
IC808	2SC4738GR	0.73 C
IC809	2SC4738GR	0.73 C
IC810	2SC4738GR	0.73 C
IC811	2SC4738GR	0.73 C
IC812	2SC4738GR	0.73 C
IC813	2SC4738GR	0.73 C
IC814	2SC4738GR	0.73 C
IC815	2SC4738GR	0.73 C
IC816	2SC4738GR	0.73 C
IC817	2SC4738GR	0.73 C
IC818	2SC4738GR	0.73 C
IC819	2SC4738GR	0.73 C
IC820	2SC4738GR	0.73 C
IC821	2SC4738GR	0.73 C
IC822	2SC4738GR	0.73 C
IC823	2SC4738GR	0.73 C
IC824	2SC4738GR	0.73 C
IC825	2SC4738GR	0.73 C

Circuit's Symbol	Model	Drawing's part's No.
D101	DSM3MA2	0.91 C
D111	D1FS6	0.92 C
D121	1SS355	0.95 C
D401	HN1D03FU	0.93 C
D403	1SS355	0.95 C
D731	-	-
D821	1SS355	0.95 C
LD201	HLMF-K305	Yellow 133 H
LD202	HLMF-K405	Orange 134 H
LD203	HLMF-K505	Green 135 H
RES1	CG1S10M05S2 10MHZ	107 R

Circuit's Symbol	Model	Drawing's part's No.
IC101	NJM2340M	0.82 C
IC121	LFS0CDT	0.83 C
IC401	S-24C04BFJ	0.84 C
IC501	H0643685A20H (AX-7R11)	0.87 C
IC521	RN5V042C	0.89 C
IC711	ULN2003ANS	0.90 C
IC801	NJM2903M	0.85 C
IC802	NJM2903M	0.85 C
IC803	NJM2903M	0.85 C
IC804	NJM2903M	0.85 C
IC805	NJM2903M	0.85 C
IC806	NJM2903M	0.85 C
IC807	NJM2903M	0.85 C
IC808	NJM2903M	0.85 C
IC809	NJM2903M	0.85 C
IC810	NJM2903M	0.85 C
IC811	NJM2903M	0.85 C
IC812	NJM2903M	0.85 C
IC813	NJM2903M	0.85 C
IC814	NJM2903M	0.85 C
IC815	NJM2903M	0.85 C
IC816	NJM2903M	0.85 C
IC817	NJM2903M	0.85 C
IC818	NJM2903M	0.85 C
IC819	NJM2903M	0.85 C
IC820	NJM2903M	0.85 C
IC821	NJM2903M	0.85 C
IC822	NJM2903M	0.85 C
IC823	NJM2903M	0.85 C
IC824	NJM2903M	0.85 C
IC825	NJM2903M	0.85 C

Circuit's Symbol	Model	Drawing's part's No.
IC101	CCP2E-20	0.8A 103 C
IC102	CCP2E-50	2.0A 104 C
IC103	CCP2E-100	5.0A 105 C
IC104	CCP2E-200	10.0A 106 C
IC105	CCP2E-500	25.0A 107 C
IC106	CCP2E-1000	50.0A 108 C
IC107	CCP2E-2000	100.0A 109 C
IC108	CCP2E-5000	250.0A 110 C
IC109	CCP2E-10000	500.0A 111 C
IC110	CCP2E-20000	1000.0A 112 C
IC111	CCP2E-50000	2500.0A 113 C
IC112	CCP2E-100000	5000.0A 114 C
IC113	CCP2E-200000	10000.0A 115 C
IC114	CCP2E-500000	25000.0A 116 C
IC115	CCP2E-1000000	50000.0A 117 C
IC116	CCP2E-2000000	100000.0A 118 C
IC117	CCP2E-5000000	250000.0A 119 C
IC118	CCP2E-10000000	500000.0A 120 C
IC119	CCP2E-20000000	1000000.0A 121 C
IC120	CCP2E-50000000	2500000.0A 122 C
IC121	CCP2E-100000000	5000000.0A 123 C
IC122	CCP2E-200000000	10000000.0A 124 C
IC123	CCP2E-500000000	25000000.0A 125 C
IC124	CCP2E-1000000000	50000000.0A 126 C
IC125	CCP2E-2000000000	100000000.0A 127 C
IC126	CCP2E-5000000000	250000000.0A 128 C
IC127	CCP2E-10000000000	500000000.0A 129 C
IC128	CCP2E-20000000000	1000000000.0A 130 C
IC129	CCP2E-50000000000	2500000000.0A 131 C
IC130	CCP2E-100000000000	5000000000.0A 132 C
IC131	CCP2E-200000000000	10000000000.0A 133 C
IC132	CCP2E-500000000000	25000000000.0A 134 C
IC133	CCP2E-1000000000000	50000000000.0A 135 C
IC134	CCP2E-2000000000000	100000000000.0A 136 C
IC135	CCP2E-5000000000000	250000000000.0A 137 C
IC136	CCP2E-10000000000000	500000000000.0A 138 C
IC137	CCP2E-20000000000000	1000000000000.0A 139 C
IC138	CCP2E-50000000000000	2500000000000.0A 140 C
IC139	CCP2E-100000000000000	5000000000000.0A 141 C
IC140	CCP2E-200000000000000	10000000000000.0A 142 C
IC141	CCP2E-500000000000000	25000000000000.0A 143 C
IC142	CCP2E-1000000000000000	50000000000000.0A 144 C
IC143	CCP2E-2000000000000000	100000000000000.0A 145 C
IC144	CCP2E-5000000000000000	250000000000000.0A 146 C
IC145	CCP2E-10000000000000000	500000000000000.0A 147 C
IC146	CCP2E-20000000000000000	1000000000000000.0A 148 C
IC147	CCP2E-50000000000000000	2500000000000000.0A 149 C
IC148	CCP2E-100000000000000000	5000000000000000.0A 150 C
IC149	CCP2E-200000000000000000	10000000000000000.0A 151 C
IC150	CCP2E-500000000000000000	25000000000000000.0A 152 C

Circuit's Symbol	Model	Drawing's part's No.
IC101	CCP2E-20	0.8A 103 C
IC102	CCP2E-50	2.0A 104 C
IC103	CCP2E-100	5.0A 105 C
IC104	CCP2E-200	10.0A 106 C
IC105	CCP2E-500	25.0A 107 C
IC106	CCP2E-1000	50.0A 108 C
IC107	CCP2E-2000	100.0A 109 C
IC108	CCP2E-5000	250.0A 110 C
IC109	CCP2E-10000	500.0A 111 C
IC110	CCP2E-20000	1000.0A 112 C
IC111	CCP2E-50000	2500.0A 113 C
IC112	CCP2E-100000	5000.0A 114 C
IC113	CCP2E-200000	10000.0A 115 C
IC114	CCP2E-500000	25000.0A 116 C
IC115	CCP2E-1000000	50000.0A 117 C
IC116	CCP2E-2000000	100000.0A 118 C
IC117	CCP2E-5000000	250000.0A 119 C
IC118	CCP2E-10000000	500000.0A 120 C
IC119	CCP2E-20000000	1000000.0A 121 C
IC120	CCP2E-50000000	2500000.0A 122 C
IC121	CCP2E-100000000	5000000.0A 123 C
IC122	CCP2E-200000000	10000000.0A 124 C
IC123	CCP2E-500000000	25000000.0A 125 C
IC124	CCP2E-1000000000	50000000.0A 126 C
IC125	CCP2E-2000000000	100

BLOCK DIAGRAM

MODEL RAK-18NH5, RAK-25NH5, RAK-35NH5

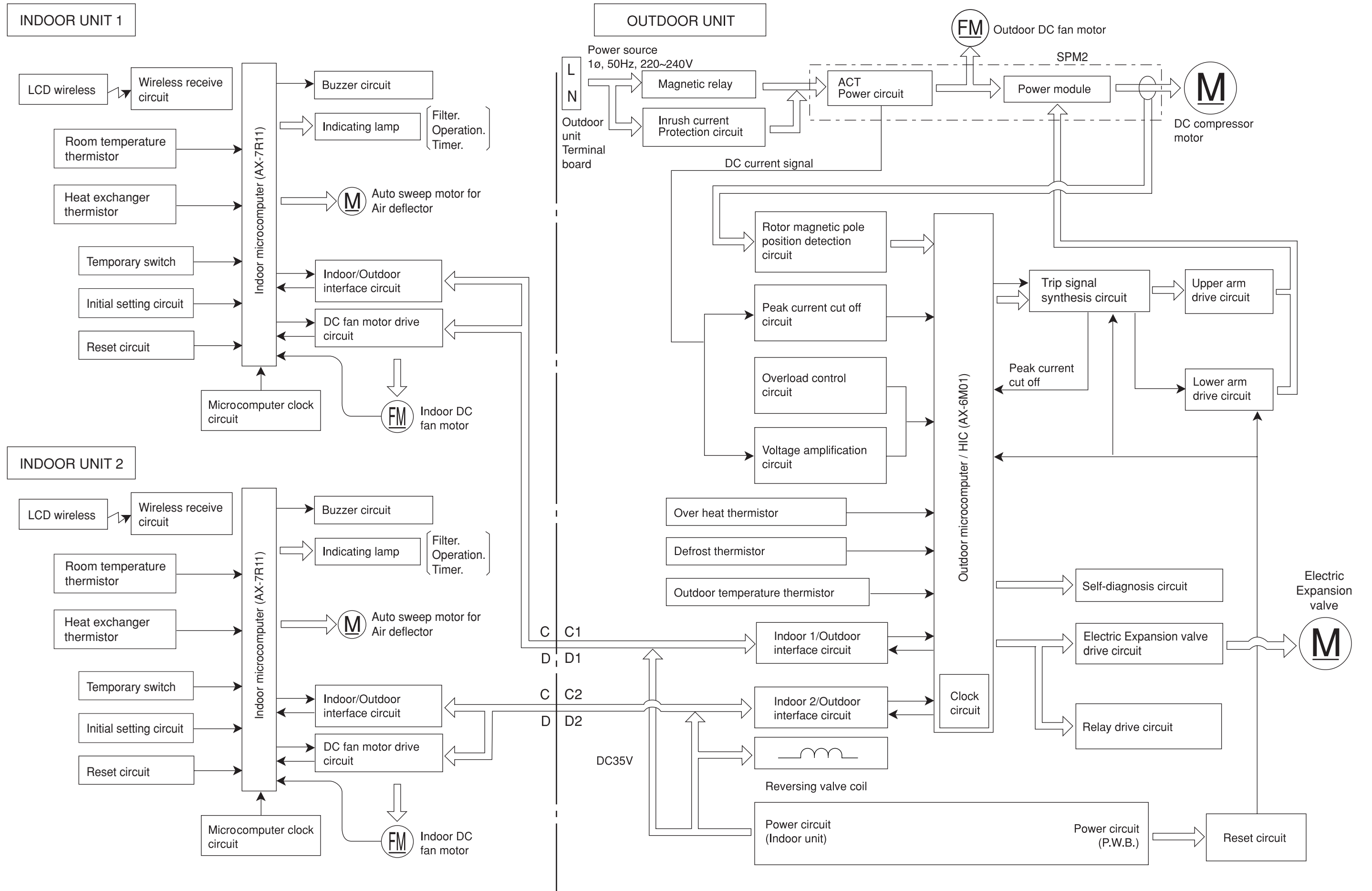

BASIC MODE

Operation mode	Fan	Cooling	Dehumidifying (dehumidifying operation by the function select button only, not including that engaged by the dehumidify button)	Heating	Auto										
Basic operation of start/stop switch															
Timer functions	Off-timer														
	On-timer														
	Off -> On On -> Off timer														
Fan speed mode (indoor fan)	Auto	<p>Changes from "Hi" to "Med" or "Lo" depending on room temperature.</p> <ol style="list-style-type: none"> Runs at "Hi" until first thermo off after operation is started. Runs at "Lo" when thermo is off. 	<p>Changes between "Lo" and "Med" depending on the room temperature.</p> <table border="1"> <thead> <tr> <th>Temperature division</th> <th>Fan speed</th> </tr> </thead> <tbody> <tr> <td>Division 1</td> <td>Lo</td> </tr> <tr> <td>Division 2</td> <td>Lo</td> </tr> <tr> <td>Division 3</td> <td>Med</td> </tr> <tr> <td>Division 4</td> <td>Med</td> </tr> </tbody> </table> <p>1. The indoor fan also stops when the compressor is in stop status.</p>	Temperature division	Fan speed	Division 1	Lo	Division 2	Lo	Division 3	Med	Division 4	Med	<p>Set to "ultra-Lo", "Lo", "Med", "Hi", "ultra-Hi" or "stop" depending on the room temperature, time and heat exchange temperature. Set to "stop" if the room temperature is 18°C in the "ultra-Lo" mode other than during preheating (cooling is recovered at 18.33°C).</p> <p>When the compressor is running at maximum speed during hot dash or when recovered from defrosting.</p> <p>In modes other than left</p>	<p>Operating mode is judged by room temperature and outdoor temperature.</p> <p>(1) Judging by outdoor temperature</p> <ul style="list-style-type: none"> Operating mode is judged by outdoor temperature. Only when the mode is not restricted by this judgment, the judgment by room temperature in the next paragraph will be performed. (a) Outdoor temperature $\geq 30^\circ\text{C}$: Restricted to cooling (b) Outdoor temperature $\leq 9^\circ\text{C}$: Restricted to heating <p>(2) Judging by room temperature</p> <p>Operating mode at start up is judged (initial judgment)</p> <p>(a) Conditions for judgment (any of the followings)</p> <ul style="list-style-type: none"> When auto operation is started after 1 hour has elapsed since the operation was stopped. When auto operation is started after the previous manual mode operation. When the operating mode is switched to auto while operating at manual mode. <p>(b) Judging method</p> <ul style="list-style-type: none"> Room temperature $\geq 23^\circ\text{C} \pm 3^\circ\text{C}$: Cooling Room temperature $< 23^\circ\text{C} \pm 3^\circ\text{C}$: Heating ※ $\pm 3^\circ\text{C}$ is the fine adjustment value from the remote controller. <p>Judging operating mode change during operation (Continuous judgment)</p> <p>(a) Conditions for judgment (any of the followings)</p> <ul style="list-style-type: none"> The mode is reviewed at every interval time. When auto operation is started again before 1 hour has elapsed since the operation was stopped. <p>(b) Judging method</p> <ul style="list-style-type: none"> Judge by setting the hysteresis on the final preset temperature. The final preset temperature is the actually targeted preset temperature which is the sum of the basic preset temperature and each type of shift value (e.g. $\pm 3^\circ\text{C}$ by remote controller, preset temperature correction value, powerful shift value, etc.). <p>[Currently cooling]</p> <ul style="list-style-type: none"> Room temperature \leq Final preset temperature -3°C Change to heating Room temperature $>$ Final preset temperature -3°C Continue cooling <p>[Currently heating]</p> <ul style="list-style-type: none"> Room temperature \geq Final preset temperature $+2^\circ\text{C}$ Change to cooling Room temperature $<$ Final preset temperature $+2^\circ\text{C}$ Continue heating
	Temperature division	Fan speed													
	Division 1	Lo													
	Division 2	Lo													
Division 3	Med														
Division 4	Med														
Hi	Operates at "Hi" regardless of the room temperature.	Set to "ultra-Hi" when the compressor runs at maximum speed, and to "Hi" in other modes.	Set to "Hi" in modes other than when the compressor stops.	Set to "ultra-Lo", "Lo", "Med", "Hi", "ultra-Hi" or "stop" depending on the room temperature, and time. Set to "stop" if the room temperature is 18°C in the "ultra-Lo" mode other than during preheating (cooling is recovered at 18.33°C). Set to "ultra-Hi" when the compressor is running at maximum speed during hot dash or when recovered from defrosting.											
Med	Operates at "Med" regardless of the room temperature.	Same as at left.	Set to "Med" in modes other than when the compressor stops.	Set to "ultra-Lo", "Lo", "Med" or "stop" depending on the room temperature and time. Set to "stop" if the room temperature is 18°C in the "ultra-Lo" mode other than during preheating (cooling is recovered at 18.33°C). The fan speed is controlled by the heat exchanger temperature; the overload control is executed as in the following diagram:											
Lo	Operates at "Lo" regardless of the room temperature.	Same as at left.	Set to "Lo" in modes other than when the compressor stops.	Set to "ultra-Lo", "Lo", or "stop" depending on the room temperature and time. Set to "stop" if the room temperature is 18°C in the "ultra-Lo" mode other than during preheating (cooling is recovered at 18.33°C). The fan speed is controlled by the heat exchanger temperature; the overload control is executed as in the following diagram:											
Basic operation of temperature controller	Performs only fan operation at the set speed regardless of the room temperature.	See page 51.	See page 55.	See page 57.											
Sleep operation (with sleep button ON)	<ul style="list-style-type: none"> Enters sleep operation after set as on the left. Action during sleep operation Lo (sleep) operation 	<ul style="list-style-type: none"> Same as at left See page 53. 	<ul style="list-style-type: none"> Same as at left See page 55. 	<ul style="list-style-type: none"> Same as at left See page 59. 	<ul style="list-style-type: none"> Same as at left. Performs the sleep operation of each operation mode. 										

Combination of operations:

When operation mode is selected:

- You cannot operate the indoor units in the following combinations.
- The indoor unit which is switched on first continues to operate, but other indoor units which is switched on later, does not operate while the lamp lights.

One unit	Other unit
Heating	Cooling
	Dehumidifying
	Circulating (fan)

During automatic operation:

- When heating operation is automatically selected for the first indoor unit, the next indoor unit will then start to heat. Also, if cooling or dehumidifying is automatically selected for the first indoor unit, the next indoor unit will also start to cool or dehumidify.

Notes:

- Refer to the PWRITE-ZU data for the constants expressed by capital alphabet letters in the drawing.
- The speed set of rotation for the fan motor in each operation mode are as shown in Table 1.
- The set room temperatures in the diagram include the shift values in Table 2.

MODEL		RAK-18NH5	RAK-25NH5	RAK-35NH5
PROM NO.	LABEL NAME	REQUIRED VALUE OF UNIT SIDE	REQUIRED VALUE OF UNIT SIDE	REQUIRED VALUE OF UNIT SIDE
0A2	RTOTSA	0°C	0°C	0°C
120	WMAX_M	5300 min-1	5300	5000 min-1
121	WMAX2_M	5300 min-1	5300	5000 min-1
122	WSTD_M	4000 min-1	4000	4000 min-1
123	WJKMAX_M	3700 min-1	3700	3700 min-1
124	WBEMAX_M	3500 min-1	3500	3500 min-1
127	CMAX_M	3300 min-1	3300 min-1	4300 min-1
128	CMAX2_M	3300 min-1	3300 min-1	3700 min-1
129	CSTD_M	3250 min-1	3250 min-1	3150 min-1
12A	CKYMAX_M	2800 min-1	2800 min-1	2800 min-1
12B	CJKMAX_M	2750 min-1	2750 min-1	2750 min-1
12C	CBEMAX_M	2500 min-1	2500 min-1	2500 min-1
12F	SDMAX_M	2400 min-1	2400 min-1	1550 min-1
130	SDRPM_M	2100 min-1	2100 min-1	1400 min-1
138	WMIN_M	800 min-1	800 min-1	800 min-1
139	CMINHI_M	800 min-1	800 min-1	800 min-1
13A	CMIN_M	1200 min-1	1200 min-1	1200 min-1
13B	DMIN_M	1200 min-1	1200 min-1	1200 min-1
13C	PKOU_M	550 min-1	550 min-1	550 min-1
13D	FZZY_GN_M	1.5	1.5	1.5
13E	FZZYTM_M	4 min	4 min	4 min
144	SHIFTW_M	2 °C	2 °C	2 °C
145	SFTSZW_M	2 °C	2 °C	2 °C
146	SHIFTC_M	1.33 °C	1.33 °C	1.33 °C
147	SHIFTD_M	3.33 °C	3.33 °C	3.33 °C
148	CLMXTP_M	30 °C	30 °C	30 °C
149	YNEOF_M	25 °C	25 °C	25 °C
14E	TEION_M	2 °C	2 °C	2 °C
14F	TEIOF_M	9 °C	9 °C	- °C
157	CMNLMT_M	0 min-1	0 min-1	0 min-1
178	FWSS_M	500 min-1	500 min-1	500 min-1
179	FWSOY_M	600 min-1	600 min-1	700 min-1
17A	FWS_M	720 min-1	750 min-1	820 min-1
17B	FWKAF_M	840 min-1	850 min-1	920 min-1
17C	FWL_M	840 min-1	850 min-1	920 min-1
17D	FWAH_M	940 min-1	1050 min-1	1120 min-1
17E	FWH_M	940 min-1	1050 min-1	1120 min-1
17F	FWHH_M	1030 min-1	1170 min-1	1250 min-1
180	FCSOY_M	550 min-1	600 min-1	680 min-1
181	FCS_M	650 min-1	750 min-1	780 min-1
182	FCL_M	740 min-1	870 min-1	950 min-1
183	FCAH_M	850 min-1	980 min-1	1030 min-1
184	FCH_M	890 min-1	1030 min-1	1170 min-1
185	FCHH_M	990 min-1	1030 min-1	1200 min-1
186	FDOY_M	600 min-1	600 min-1	680 min-1
187	FDS1_M	720 min-1	750 min-1	780 min-1
188	FDS2_M	720 min-1	750 min-1	780 min-1

Table 1 Fan speed by mode

Operation mode	Fan speed mode		Label name
Heating operation	Ultra Lo		FWSS_M
	Sleep		FWSOY_M
	Lo		FWS_M
	Overload		FWKAF_M
	Med		FWL_M
	Hi	Set fan speed "AUTO"	FWAH_M
	Hi	Set fan speed "Hi"	FWH_M
	Ultra Hi		FWHH_M
Cooling operation	Sleep		FCSOY_M
	Lo		FCS_M
	Med		FCL_M
	Hi	Set fan speed "AUTO"	FCAH_M
	Hi	Set fan speed "Hi"	FCH_M
	Ultra Hi		FCHH_M
Dehumidifying operation	Sleep		FDOY_M
	Lo 1		FDS1_M
	Lo 2		FDS2_M

Table 2 Room temperature shift value

Operation mode	Fan speed mode	Shift value
Heating operation	Fan speed "AUTO, Hi, Med"	SHIFTW_M
	Fan speed "Lo, Sleep"	SFTSZW_M
Cooling operation		SHIFTC_M
Dehumidifying operation		SHIFTD_M

Basic Cooling Operation

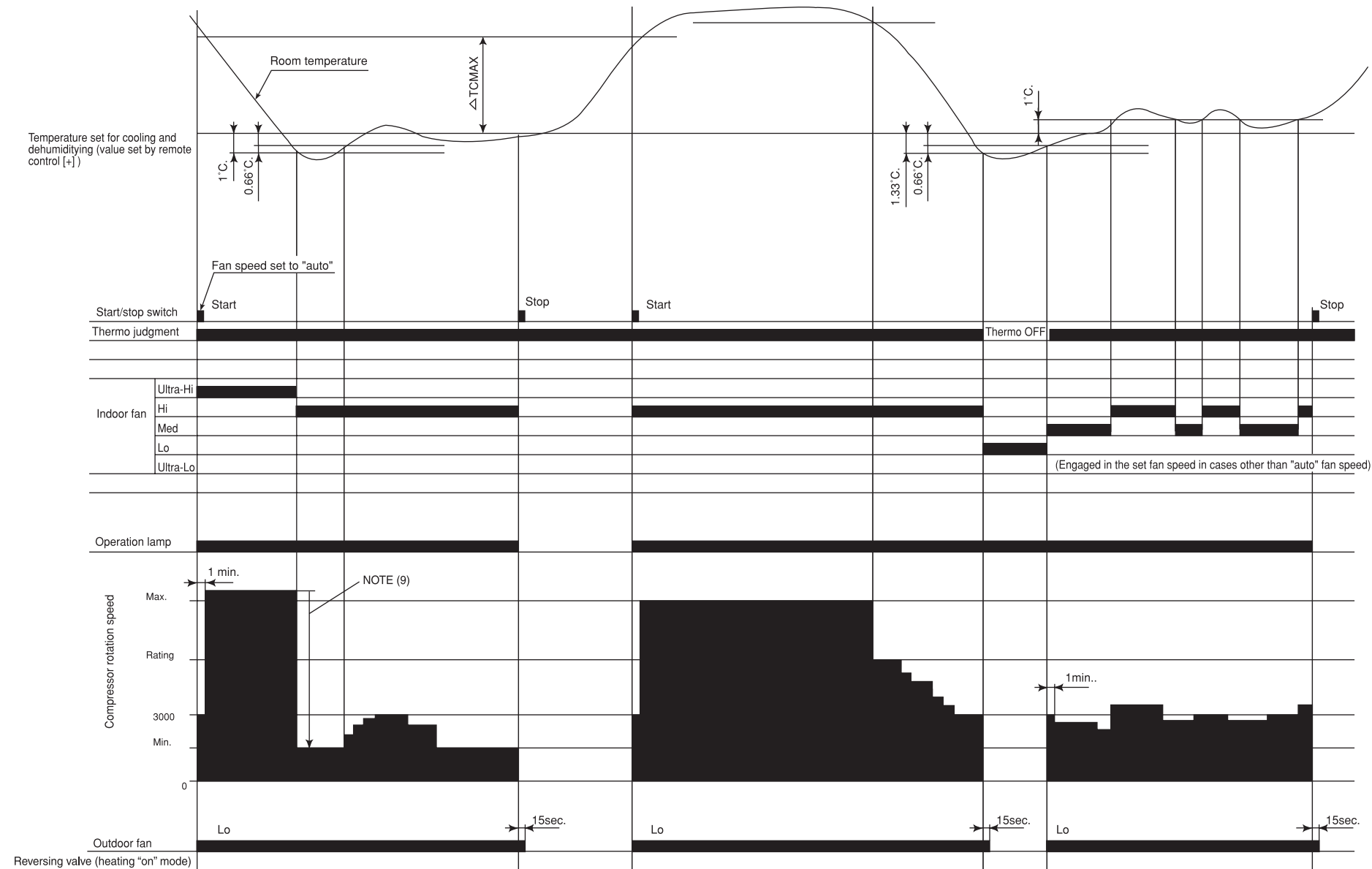

Notes:

- (1) Condition for entering into Cool Dashed mode. When fan set to "Hi" or "Auto mode" and temperature difference between indoor temperature and set temperature has a corresponding compressor rpm (calculated value in Table 3) larger than WMAX.
- (2) Cool Dashed will release when i) a maximum 25 minutes is lapsed and ii) room temperature is lower than set temperature -3°C (thermo off) and iii) when room temperature has achieved setting temperature -1°C then maximum Cool Dashed time will be revised to 20 minutes. And iv) indoor fan is set to Lo and Med fan mode and v) change operation mode.
- (3) During Cool Dashed operation, thermo off temperature is set temperature (with shift value) -3°C . After thermo off, operation continue in Fuzzy control mode.
- (4) Compressor minimum "ON" time and "OFF" time is 3 minutes.
- (5) During normal cooling mode, compressor maximum rpm CMAX will maintain for 60 minutes if indoor temperature is lower than CLMXTP. No time constrain if indoor temperature is higher than CLMXTP.
- (6) When fan is set to "Hi", compressor rpm will be limited to CKYMAX.
- (7) When fan is set to "Med", compressor rpm will be limited to CJKMAX.
- (8) When fan is set to "Lo", compressor rpm will be limited to CBEMAX.
- (9) During Cool Dashed, when room temperature reaches set temperature -1°C compressor rpm is actual rpm x DWNRATEC.

Table 3 ΔTCMAX

Temperature difference	Calculated compressor rpm
1.66	2265 min^{-1}
2	2435 min^{-1}
2.33	2600 min^{-1}
2.66	2765 min^{-1}
3	2935 min^{-1}
3.33	3100 min^{-1}
3.66	3265 min^{-1}
4	3435 min^{-1}
4.33	3600 min^{-1}
4.66	3765 min^{-1}
5	3935 min^{-1}
5.33	4100 min^{-1}
5.66	4265 min^{-1}
6	4435 min^{-1}
6.33	4600 min^{-1}
6.66	4765 min^{-1}
7	4935 min^{-1}
7.33	5100 min^{-1}
7.66	5265 min^{-1}
8	5435 min^{-1}
8.33	5600 min^{-1}
8.66	5765 min^{-1}
9	5935 min^{-1}
9.33	6100 min^{-1}
9.66	6265 min^{-1}
10	6435 min^{-1}
10.33	6600 min^{-1}
10.66	6765 min^{-1}
11	6935 min^{-1}

New Cool Rhythm

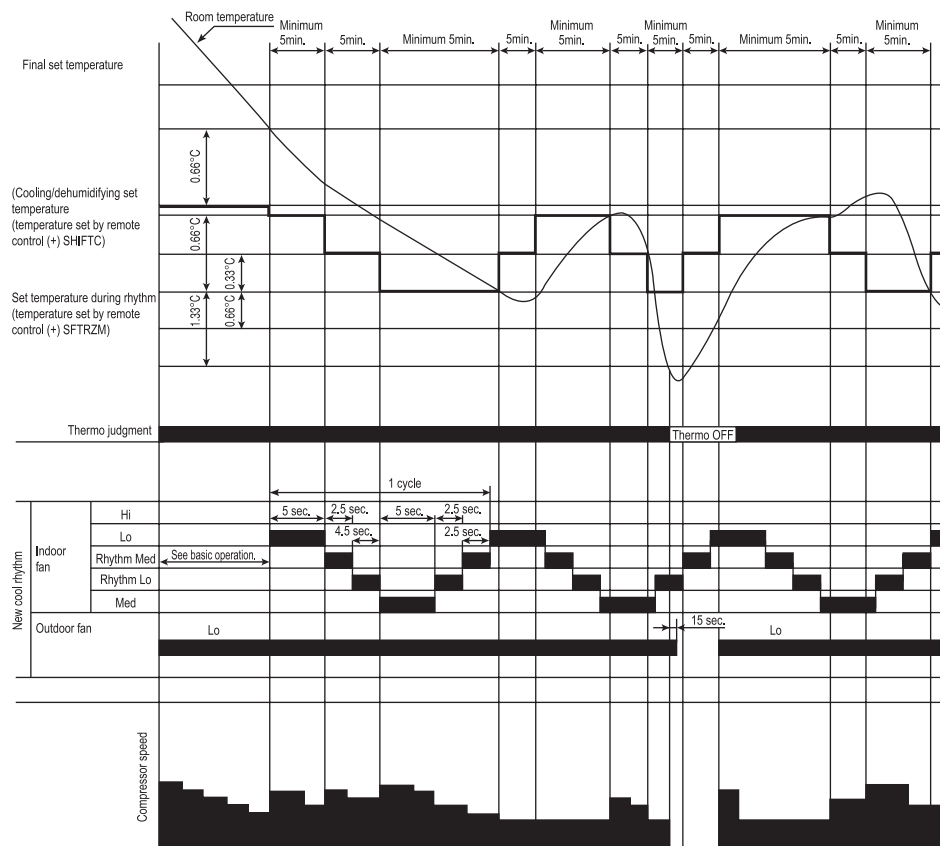

Notes:

- (1) New cool rhythm is engaged when the fan speed is "auto" and the room temperature is less than set one plus 0.66°C in the "auto" operation mode or cooling mode.
- (2) The minimum new cool rhythm time is 10 minutes when the temperature falls and rises.
- (3) Cool rhythm is not engaged during Nice temperature, Sleep operation.
- (4) PI control is engaged during new cool rhythm: the speed limit is the same as during normal operation.
- (5) The new cool rhythm set temperature is also shifted during thermo OFF.

Cooling Defrost

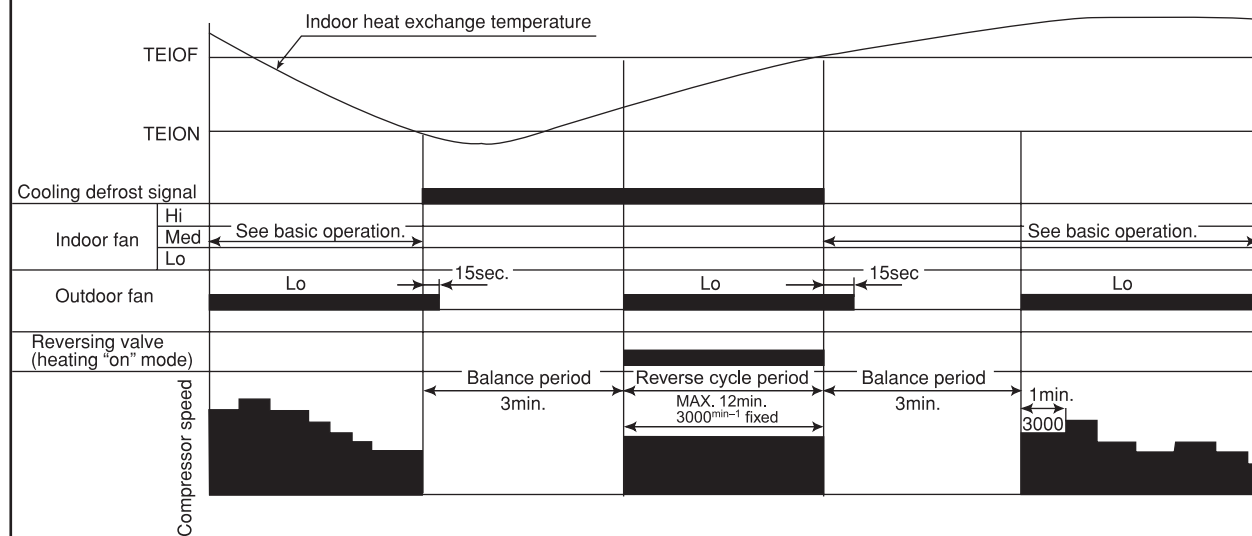

Cooling Sleep Operation

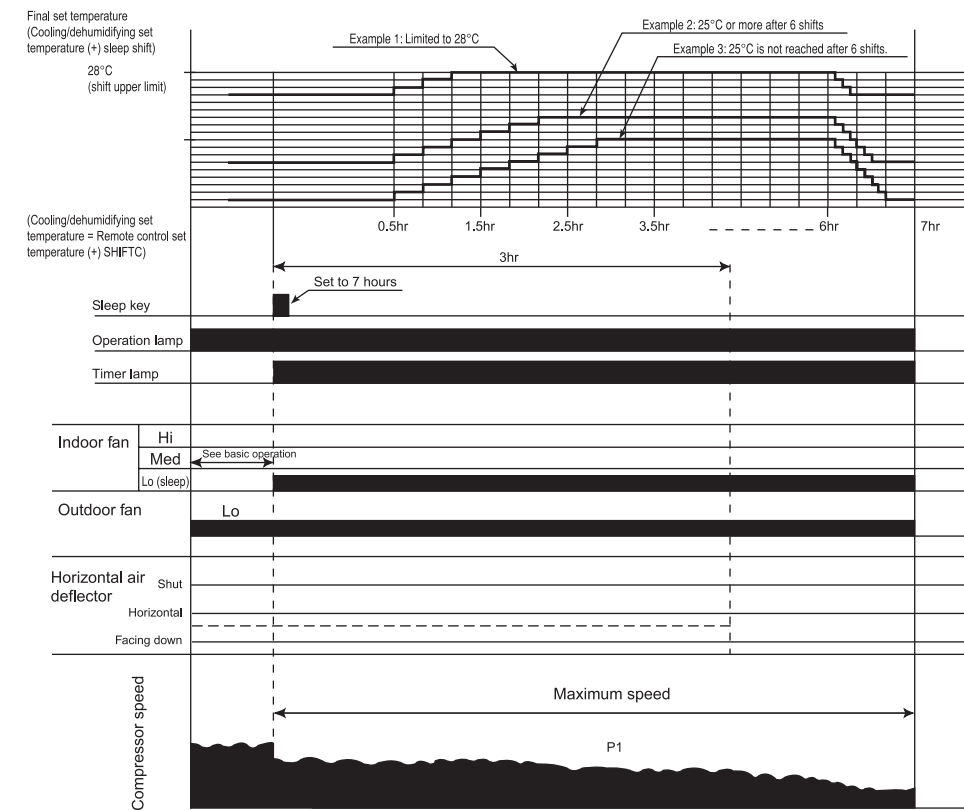

Notes:

- (1) The sleep operation starts when the sleep key is pressed.
- (2) When the sleep key is set, the maximum compressor speed is limited, and the indoor fan is set to "sleep Lo".
- (3) 30 minutes after the sleep key is set, the sleep shift of temperature starts, and upper shift is made at least 6 times. If 25°C is not reached after 6 shifts, shifts repeat until 25°C is reached.
- (4) The sleep shift upper value of set temperature is 28°C.
- (5) After 6 hours, a shift down to the initial set temperature is made at a rate of 0.33°C/5 min.
- (6) If the operation mode is changed during sleep operation, the set temperature is cleared, and shift starts from the point when switching is made.
- (7) The indoor fan speed does not change even when the fan speed mode is changed.
- (8) When operation is stopped during sleep operation, the set temperature when stopped, as well as the time, continue to be counted.
- (9) If the set time is changed during sleep operation, all data including set temperature, time, etc. is cleared and restarted.
- (10) If sleep operation is canceled by the cancel key or sleep key, all data is cleared.

Dehumidifying

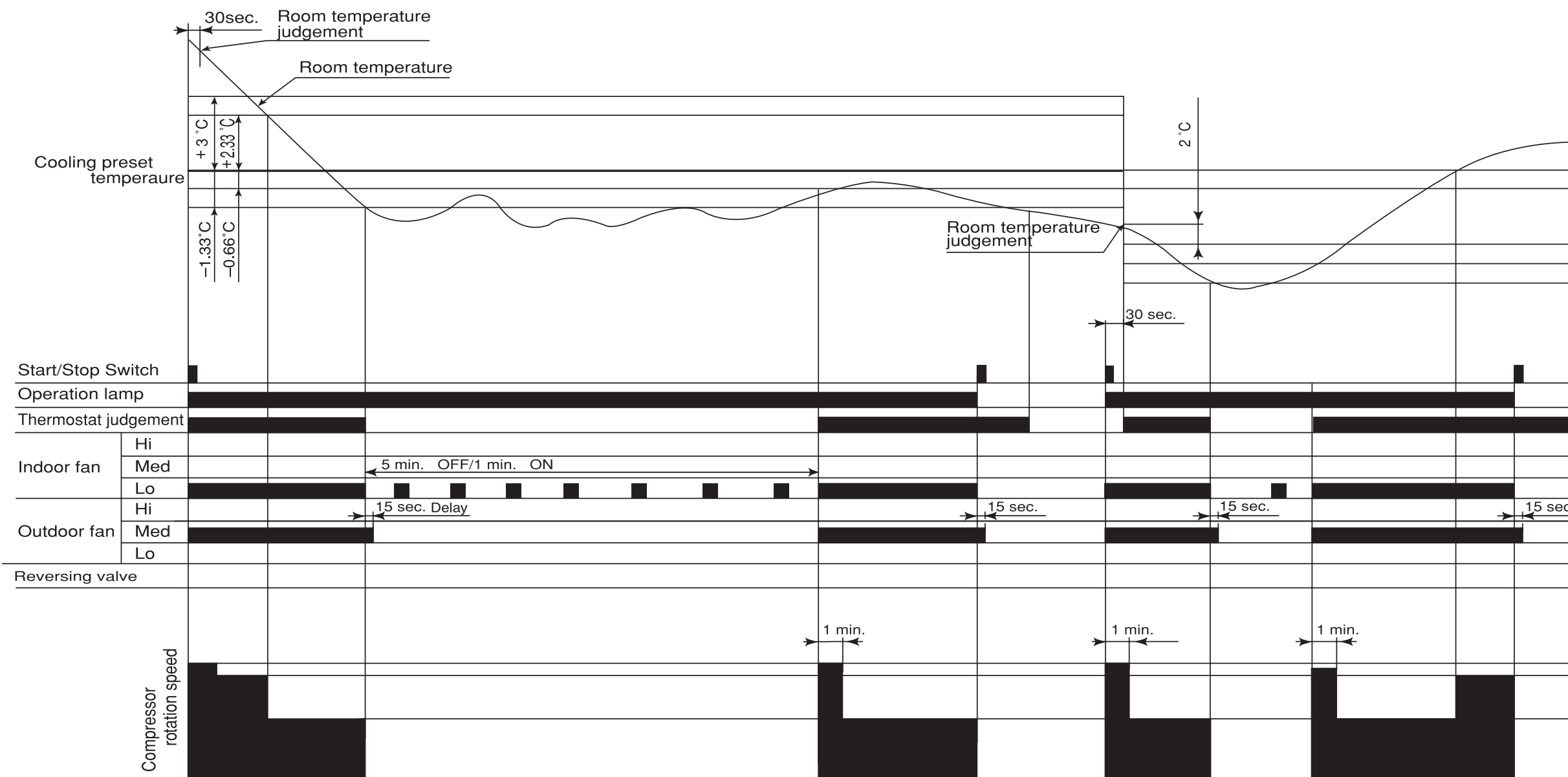

Notes:

- (1) If the room temperature is (cooling preset temperature) - (1.33°C) or less after 30 seconds from starting the operation, the operation is done assuming as the preset temperature = (room temperature at the time) - (2°C).
- (2) The indoor fan is operated in the "Lo" mode. During thermo OFF indoor fan will be OFF for 5 minutes and ON for 1 minute.
- (3) When the operation is started by the thermostat turning ON, the start of the indoor fan is delayed 32 seconds after the start of compressor operation.
- (4) The compressor is operated forcedly for 3 minutes after operation is started.
- (5) The minimum ON time and OFF time of the compressor are 3 minutes.

Dehumidifying Sleep Operation

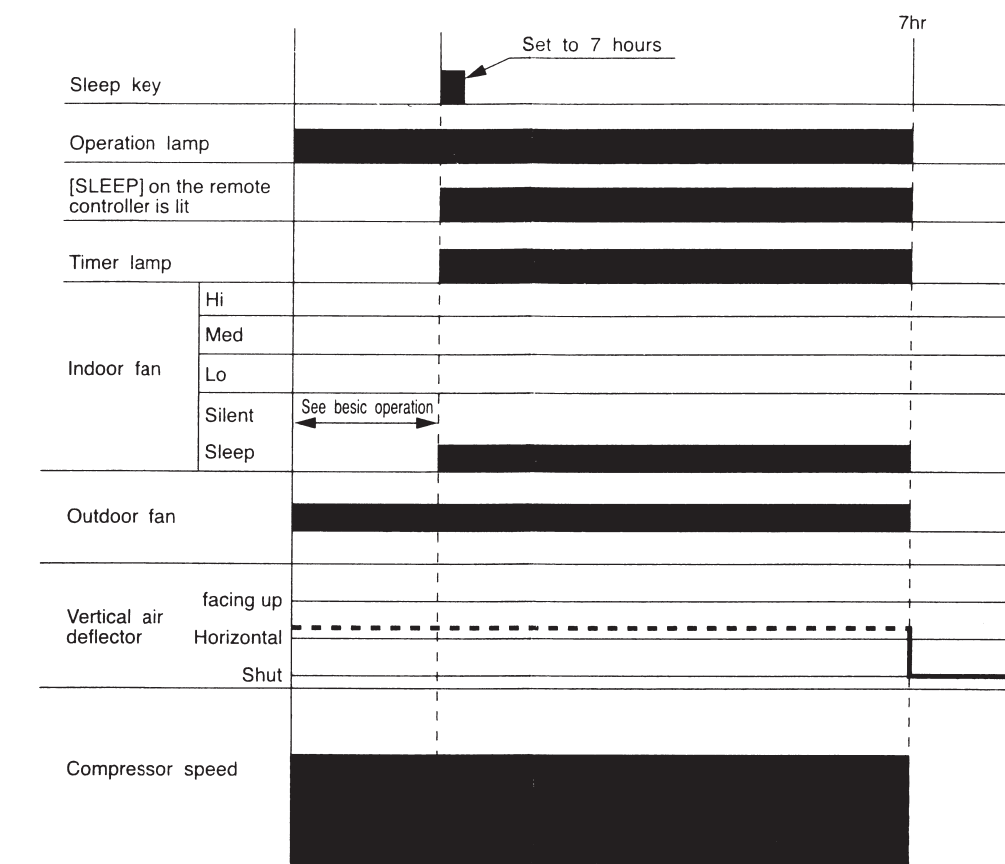

Notes:

- (1) The sleep operation starts when the sleep key is pressed.
- (2) When the sleep key is set, the indoor fan is set to "sleep silent" (FDOY_M or AFDOY).
- (3) The indoor fan speed does not change even when the fan speed mode is changed.
- (4) If the set time is changed during sleep operation, all data including set temperature, time, etc. is cleared and restarted.
- (5) If sleep operation is canceled by the cancel key or sleep key, all data is cleared.
- (6) If the position of air deflector is being operated using remote control, the operation will be performed at any desired position of air deflector.

Basic Heating Operation

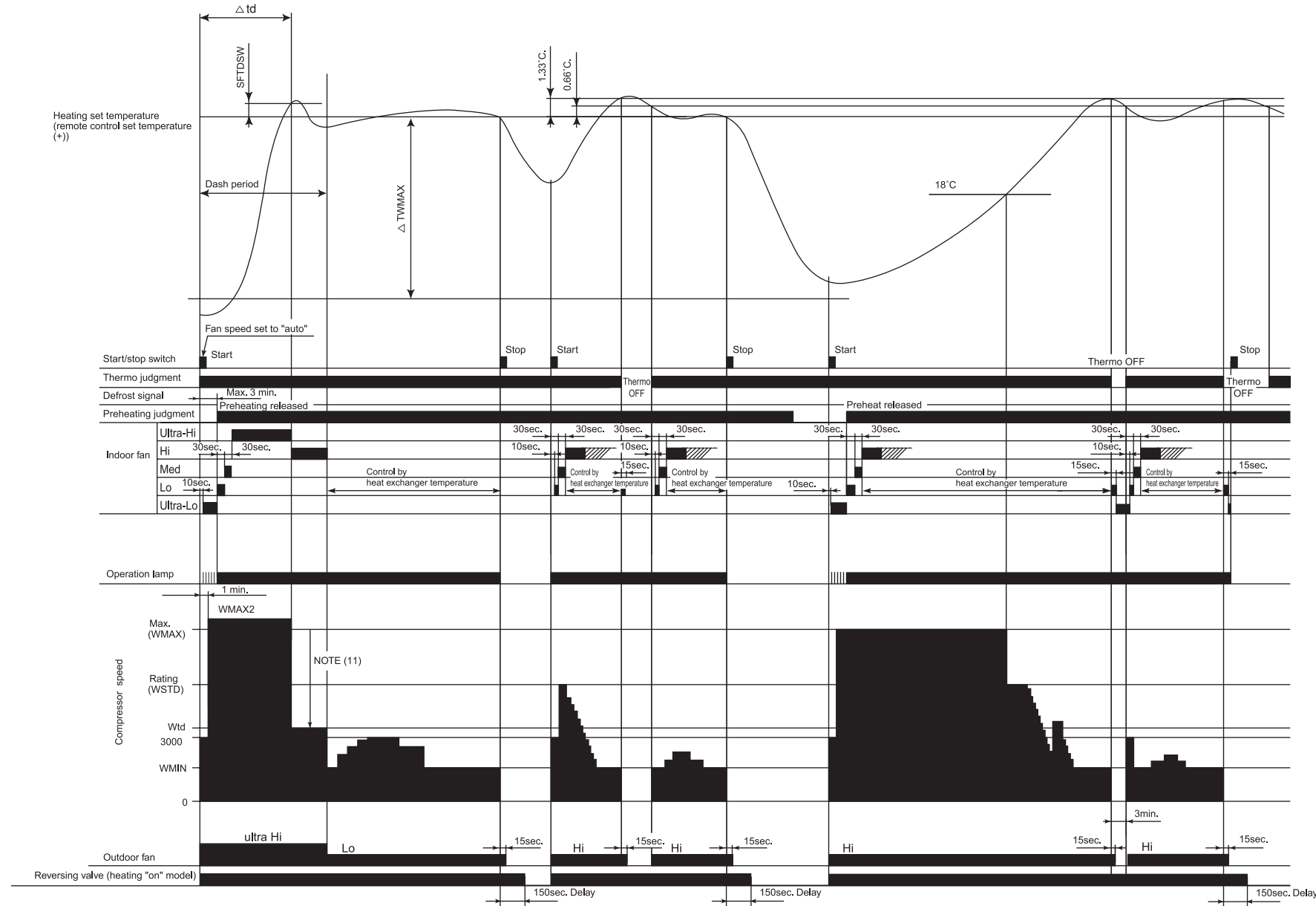

Table 4 ΔTWMAX

Temperature difference	Calculated compressor rpm
1.66	1965 min ⁻¹
2	2135 min ⁻¹
2.33	2300 min ⁻¹
2.66	2465 min ⁻¹
3	2635 min ⁻¹
3.33	2800 min ⁻¹
3.66	2965 min ⁻¹
4	3135 min ⁻¹
4.33	3300 min ⁻¹
4.66	3465 min ⁻¹
5	3635 min ⁻¹
5.33	3800 min ⁻¹
5.66	3965 min ⁻¹
6	4135 min ⁻¹
6.33	4300 min ⁻¹
6.66	4465 min ⁻¹
7	4635 min ⁻¹
7.33	4800 min ⁻¹
7.66	4965 min ⁻¹
8	5135 min ⁻¹
8.33	5300 min ⁻¹
8.66	5465 min ⁻¹
9	5635 min ⁻¹
9.33	5800 min ⁻¹
9.66	5965 min ⁻¹
10	6135 min ⁻¹
10.33	6300 min ⁻¹
10.66	6465 min ⁻¹
11	6635 min ⁻¹

Notes:

- (1) Condition for entering into Hot Dashed mode. When fan set to "Hi" or "Auto mode" and i) Indoor temperature is lower than 18°C, and ii) outdoor temperature is lower than 10°C, and iii) Temperature difference between indoor temperature and set temperature has a corresponding compressor rpm (calculated value in Table 4) larger than WMAX.
- (2) Hot Dashed will release when i) Room temperature has achieved the set temperature + SFTDSW. ii) Thermo off.
- (3) During Hot Dashed operation, thermo off temperature is set temperature (with shift value) +3°C. After thermo off, operation continue in Fuzzy control mode.
- (4) Compressor minimum "ON" time and "OFF" time is 3 minutes.
- (5) During normal heating mode, compressor maximum rpm WMAX will maintain for 120 minutes if indoor temperature is higher than 18°C. No time limit constrain if indoor temperature is lower than 18°C and outdoor temperature is lower than 2°C.
- (6) During Hotkeep or Defrost mode, indoor operation lamp will blink at interval of 3 seconds "ON" and 0.5 second "OFF".
- (7) When heating mode starts, it will enter into Hotkeep mode if indoor heat exchanger temperature is lower than YNEOF + 0.33°C.
- (8) When fan is set to "Med" or "Lo", compressor rpm will be limited to WBEMAX.
- (9) In "Ultra-Lo" fan mode, if indoor temperature is lower than 18°C, indoor fan will stop. If indoor temperature is higher than 18°C + 0.33°C, fan will continue in "Ultra-Lo" mode. During Hotkeep or Defrost mode, fan will continue in "Ultra-Lo" mode.
- (10) During Hot Dashed or outdoor temperature is lower than -5°C, compressor rpm is WMAX2.
- (11) During Hot Dashed, when room temperature reaches set temperature + SFTDSW compressor rpm is actual rpm x DWNRATEW.

Reversing Valve Defrosting

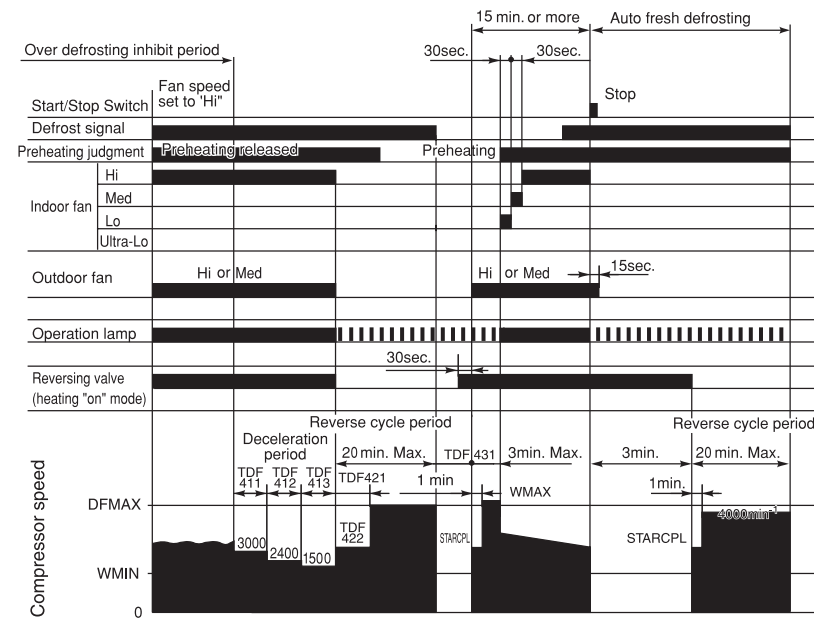

Notes:

- (1) The defrosting inhibit period is set as shown in the diagram below. When defrosting has finished once, the inhibit period is newly set, based on the outdoor temperature when the compressor was started. During this period, the defrost signal is not accepted.
- (2) If the difference between the room and outdoor temperatures is large when defrosting is finished, the maximum compressor speed (WMAX) or (WMAX2) can be continued for 120 minutes maximum.
- (3) The defrosting period is 20 minutes maximum.
- (4) When operation is stopped during defrosting, it is switched to auto refresh defrosting.
- (5) Auto refresh defrosting cannot be engaged within 15 minutes after operation is started or defrosting is finished.

Setting Defrosting Inhibit Period

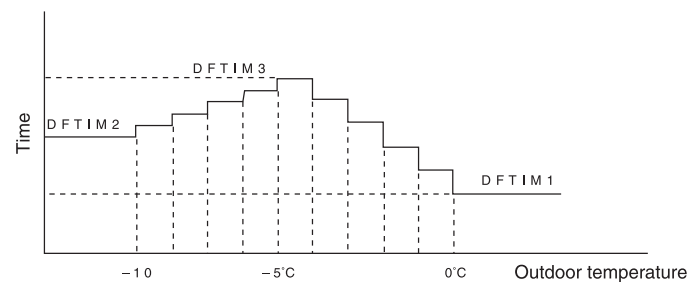

Notes:

- (1) The first inhibit time after operation start is set to DFTIM1.
- (2) From the second time onwards, the inhibit time is set according to the time required for defrosting.
Reverse cycle operation time \geq [DEFCOL] : DEFTIM1 is set.
Reverse cycle operation time $<$ [DEFCOL] : The time corresponding to outdoor temperature is set.

Heating Sleep Operation

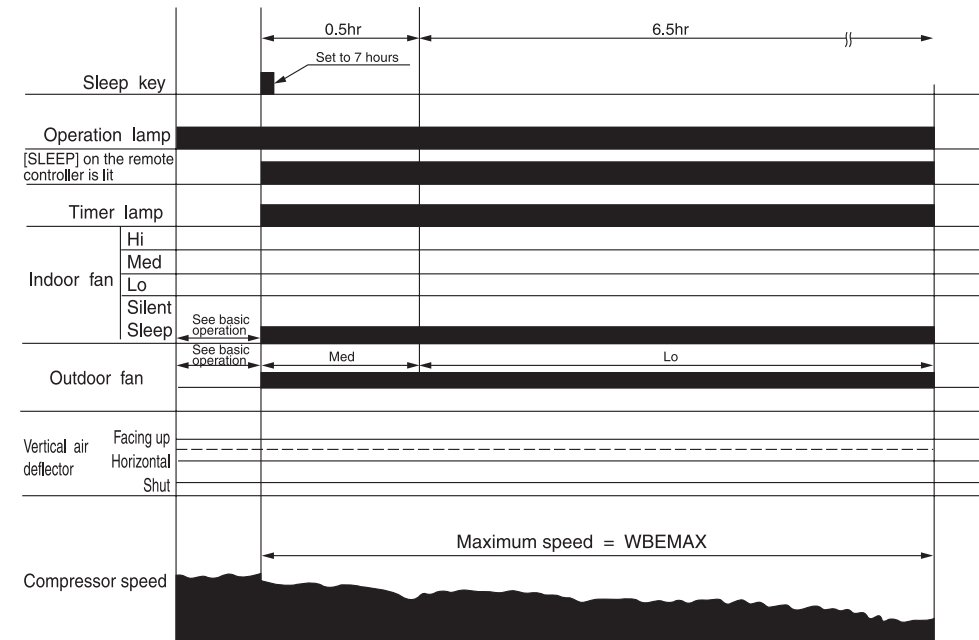

Notes:

- (1) The sleep operation starts when the sleep key is pressed.
- (2) When the sleep key is set, the maximum compressor speed is limited to WBEMAX, and the indoor fan is set to "Sleep Silent" (FWSOY).
- (3) If the operation mode is changed during sleep operation, the changed operation mode is set and sleep control starts.
- (4) The indoor fan speed does not change even when the fan speed mode is changed. (Lo)
- (5) When defrosting is to be set during sleep operation, defrosting is engaged and sleep operation is restored after defrosting.
- (6) When operation is stopped during sleep operation, the set temperature when stopped, as well as the time, continue to be counted.
- (7) If the set time is changed during sleep operation, all data including set temperature, time, etc. is cleared and restarted.
- (8) If sleep operation is cancelled by the cancel key or sleep key all data is cleared.
- (9) There is no preset temperature shift due to time elapse.

NOTE

1. Refer to the PWRITE-ZU data for the constants expressed by capital alphabet letters in the drawing.

REFRIGERATING CYCLE DIAGRAM RAK-18NH5, RAK-25NH5, RAK-35NH5

Cooling, dehumidifying, defrosting

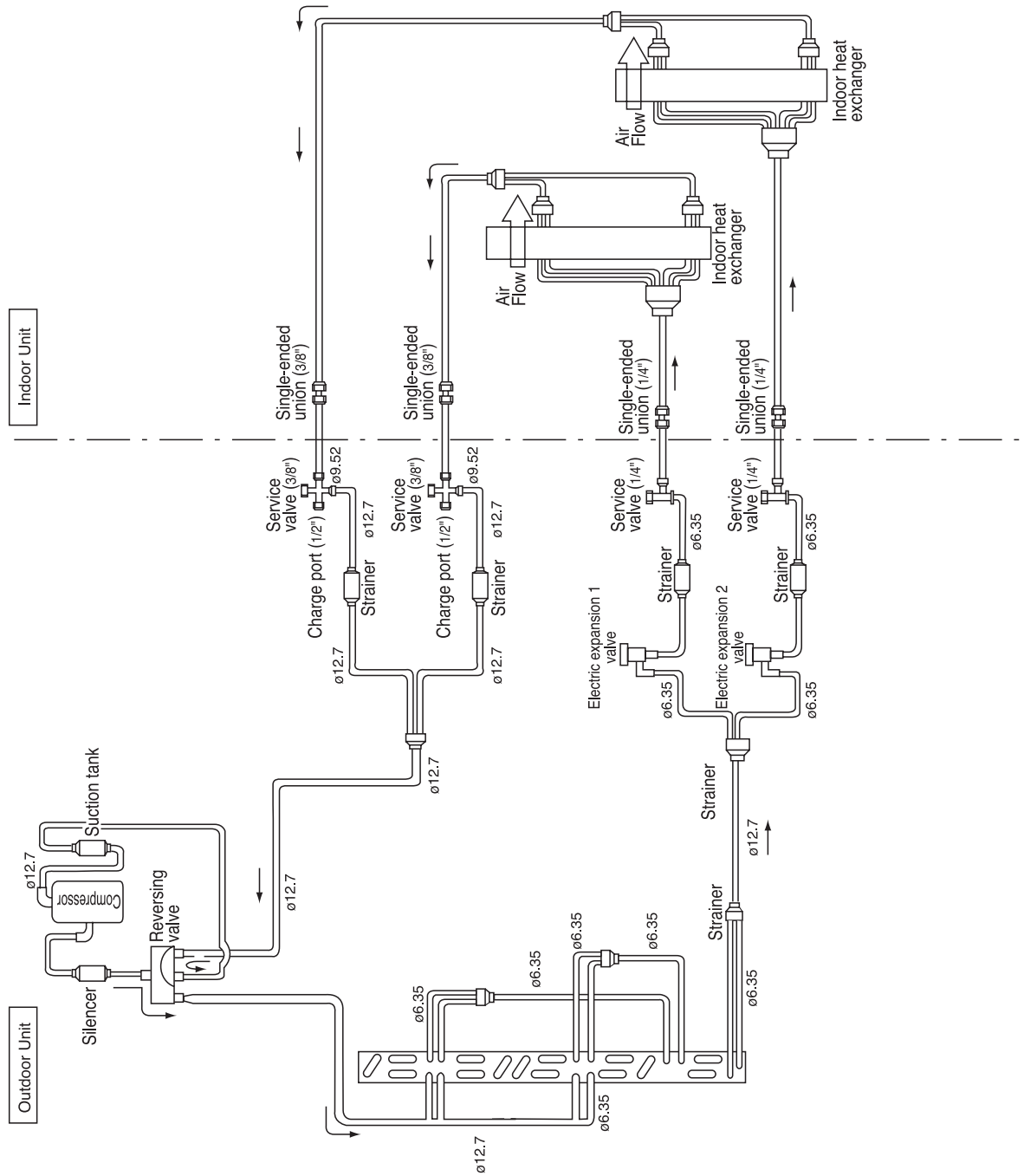

REFRIGERATING CYCLE DIAGRAM RAK-18NH5, RAK-25NH5, RAK-35NH5

Heating

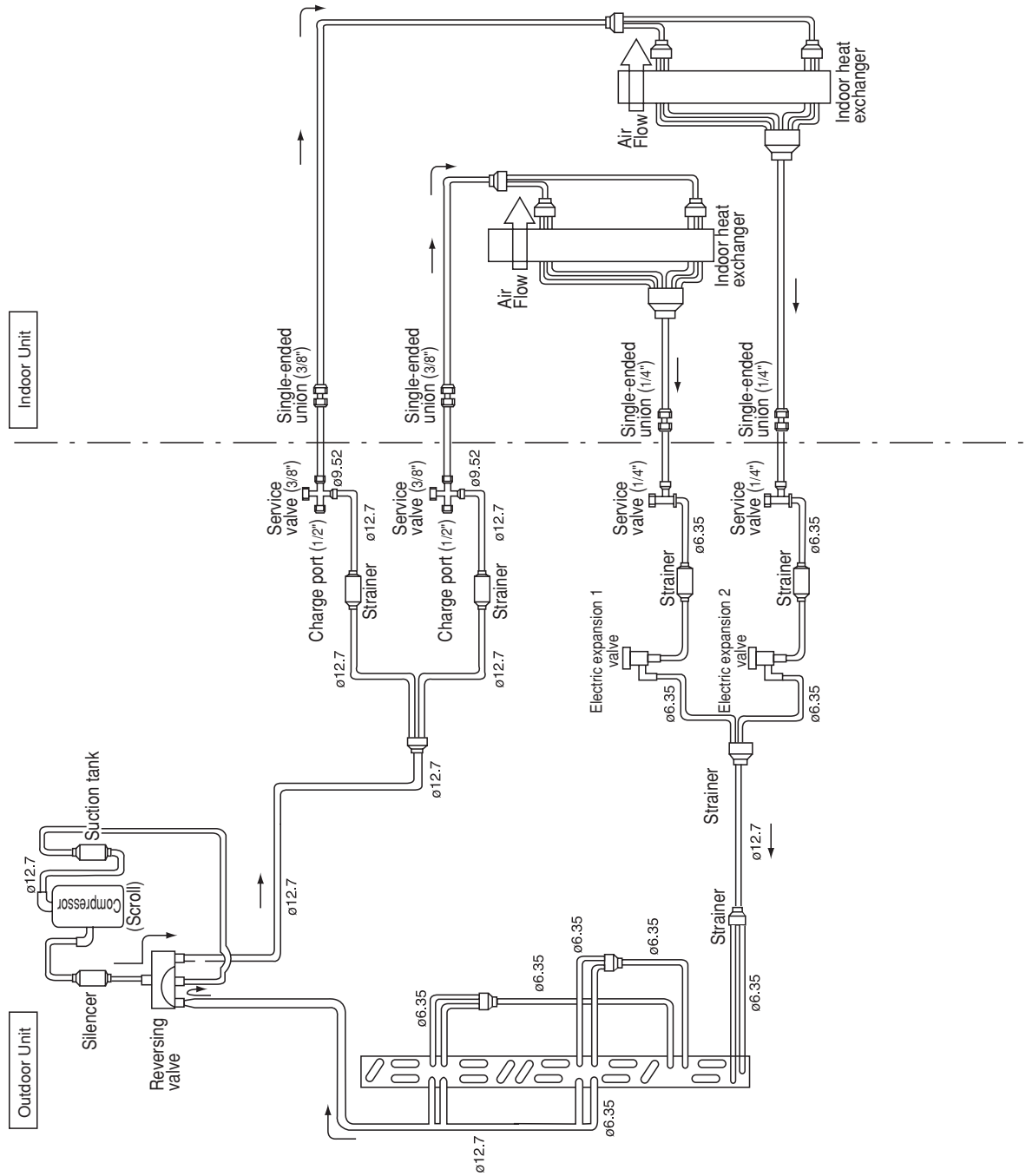

AUTO SWING FUNCTION

MODEL: RAK-18NH5, RAK-25NH5, RAK-35NH5

INPUT SIGNAL	PRESENT CONDITION		OPERATING SPECIFICATION	REFERENCE
	OPERATION	OPERATION MODE		
KEY INPUT	STOP	EACH MODE	STOP	ONE SWING (CLOSING AIR DEFLECTOR) ① DOWNWARD ② UPWARD
	DURING OPERATION	AUTO COOL COOL FAN AUTO DRY DRY	DURING ONE SWING	STOP AT THE MOMENT. START SWINGING ① DOWNWARD ② UPWARD ③ DOWNWARD
THERMO. ON (INTERNAL FAN ON)	DURING OPERATION	AUTO HEAT HEAT CIRCULATOR	STOP	START SWINGING ① DOWNWARD ② UPWARD ③ DOWNWARD
	DURING OPERATION	AUTO DRY DRY AUTO HEAT HEAT CIRCULATOR	DURING SWINGING	STOP AT THE MOMENT. START SWING AGAIN.
THERMO. ON (INTERNAL FAN OFF)	STOP	COOL FAN DRY HEAT CIRCULATOR	STOP DURING ONE SWING	INITIALIZE ① DOWNWARD ② UPWARD
	DURING OPERATION	EACH MODE	STOP DURING ONE SWING	INITIALIZE ① DOWNWARD
CHANGE OF OPERATION	DURING OPERATION	EACH MODE	STOP DURING SWINGING DURING INITIALIZING	ONE SWING (CLOSING AIR DEFLECTOR) ① DOWNWARD ② UPWARD
	DURING OPERATION	EACH MODE	STOP	INITIALIZING CONDITION OF EACH MODE.
			DURING SWINGING	STOP SWINGING AND MODE BECOMES INITIALIZING CONDITION.

DESCRIPTION OF MAIN CIRCUIT OPERATION

RAK-18NH5, RAK-25NH5, RAK-35NH5

1. Reset Circuit

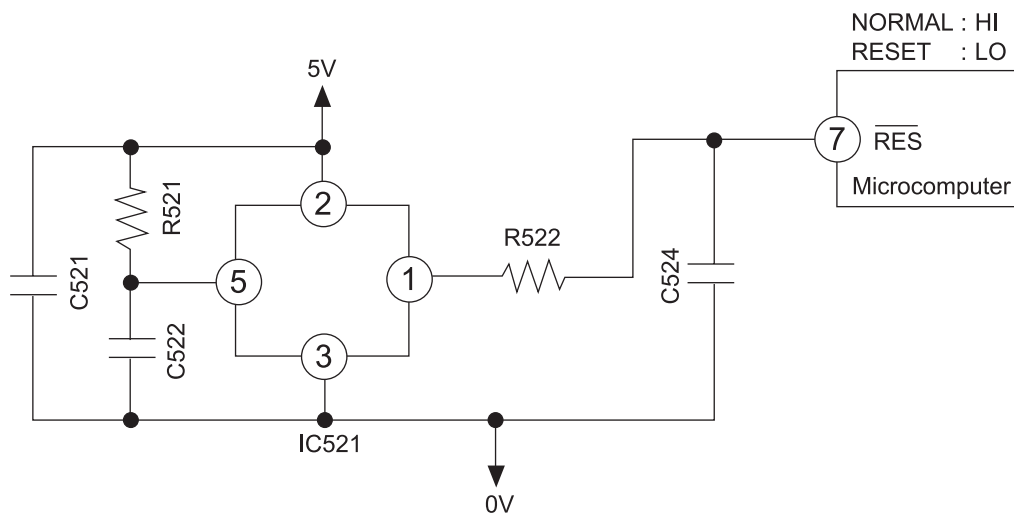

Fig. 1-1

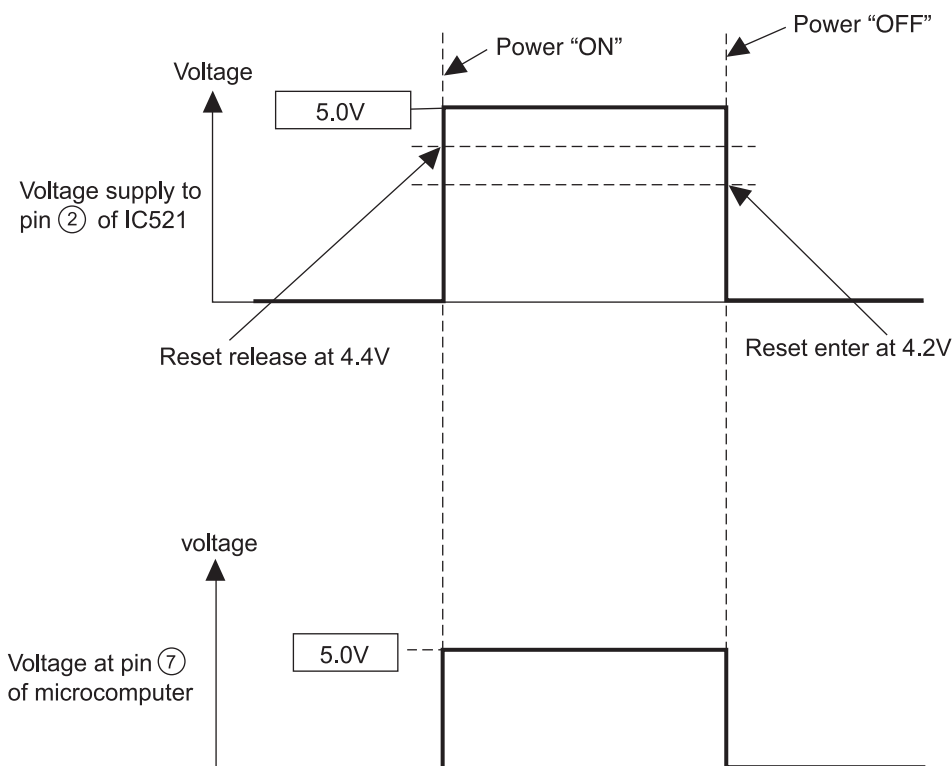

Fig. 1-2

- The reset circuit initializes the microcomputer program when power is ON or OFF.
- Low voltage at pin ⑦ resets the microcomputer and Hi activates the microcomputer.
- When power "ON" 5V voltage rises and reaches 4.4V, pin ① of IC521 is set to "Hi". At this time the microcomputer starts operation.
- When power "OFF" voltage drops and reaches 4.2V, pin ① of IC521 is set to "Low". This will RESET the microcomputer.

2. Receiver Circuit

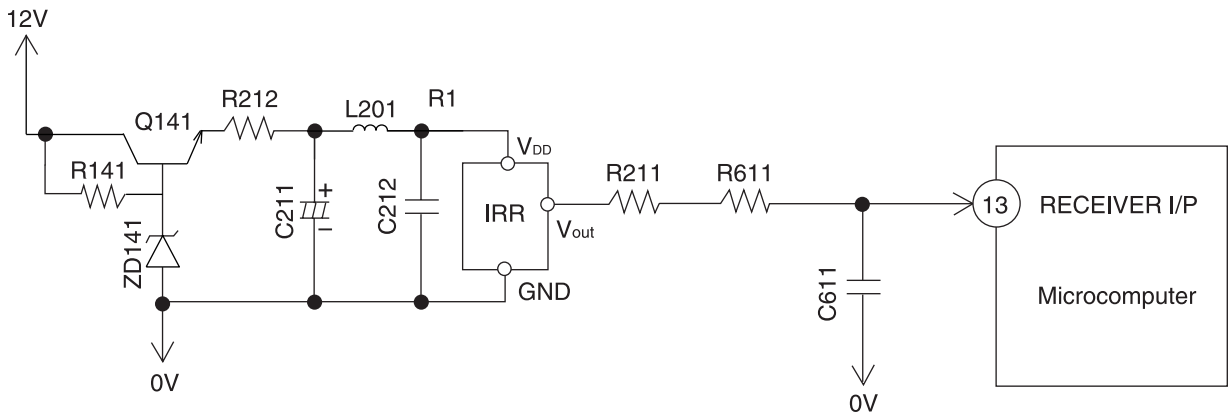

Fig. 2-1

- The light receiver unit receives the infrared signal from the wireless remote control. The receiver amplifies and shapes the signal and outputs it.

3. Buzzer Circuit

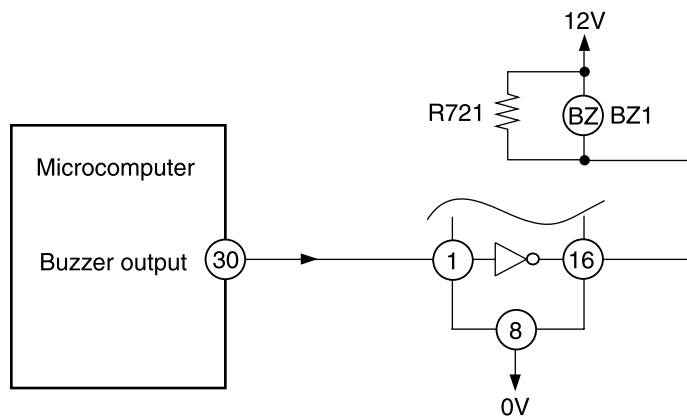

Fig. 3-1 Buzzer Circuit

- When the buzzer sounds, an approx. 3.9kHz square signal is output from buzzer output pin (30) of the microcomputer. After the amplitude of this signal has been set to 12Vp-p by a transistor, it is applied to the buzzer. The piezoelectric element in the buzzer oscillates to generate the buzzer's sound.

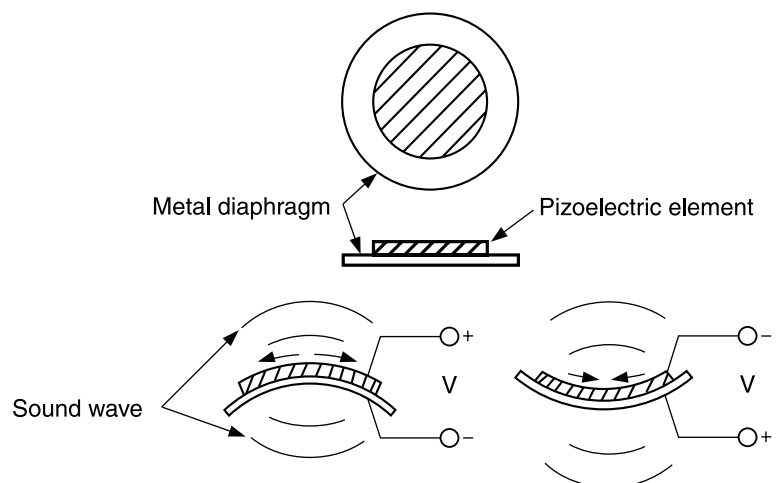

Fig. 3-2 Buzzer Operation

4. Auto Sweep Motor Circuit

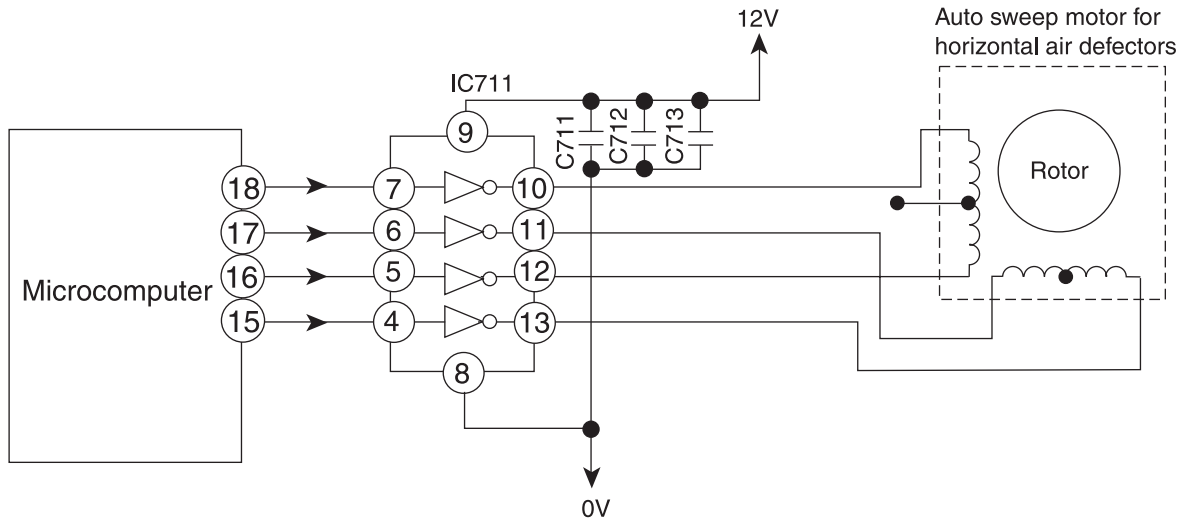

Fig.4-1

- Fig. 4-1 shows the Auto sweep motor drive circuit; the signals shown in Fig.4-2 are output from pins ⑮ – ⑱ of microcomputer.

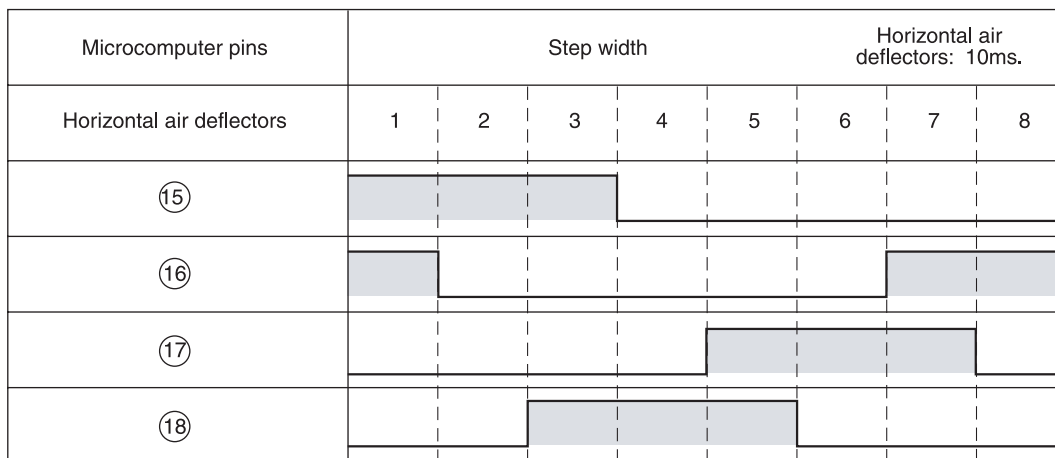

Fig.4-2 Microcomputer Output Signals

- As the microcomputer's outputs change as shown in Fig.4-2, the core of the auto sweep motor is excited to turn the rotor. Table 4-1 shows the rotation angle of horizontal air deflectors.

Table 4-1 Auto sweep Motor Rotation

	Rotation angle per step (°)	Time per step (ms.)
Horizontal air deflectors	0.0882	10

5. Room Temperature Thermistor Circuit

- Fig. 5-1 shows the room temperature thermistor circuit.

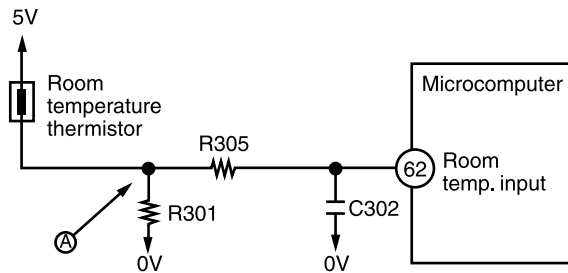

Fig. 5-1

- The voltage at Ⓐ depends on the room temperature as shown in Fig. 5-2.

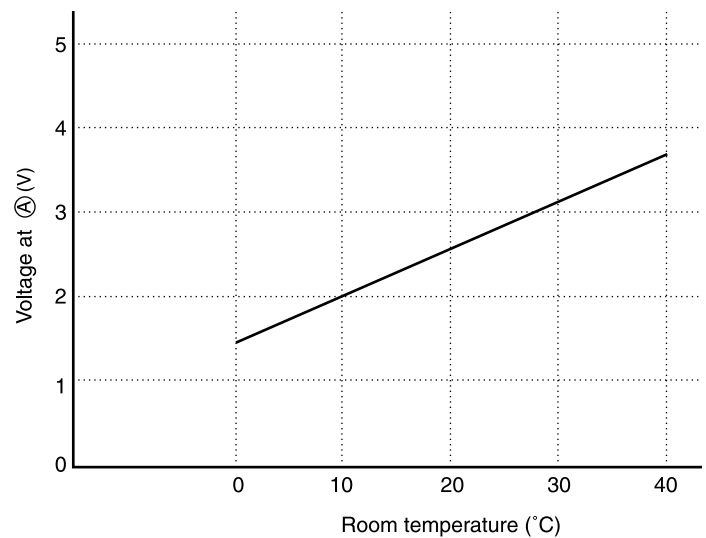

Fig. 5-2

6. Heat exchanger temperature thermistor circuit

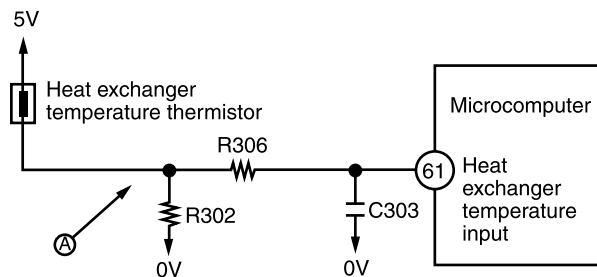

Fig. 6-1

- The circuit detects the indoor heat exchanger temperature and controls the following.

- (1) Preheating.
- (2) Low-temperature defrosting during cooling and dehumidifying operation.
- (3) Detection of the reversing valve non-operation or heat exchanger temperature thermistor open.

The voltage at Ⓐ depends on the heat exchanger temperature as shown in Fig. 6-2.

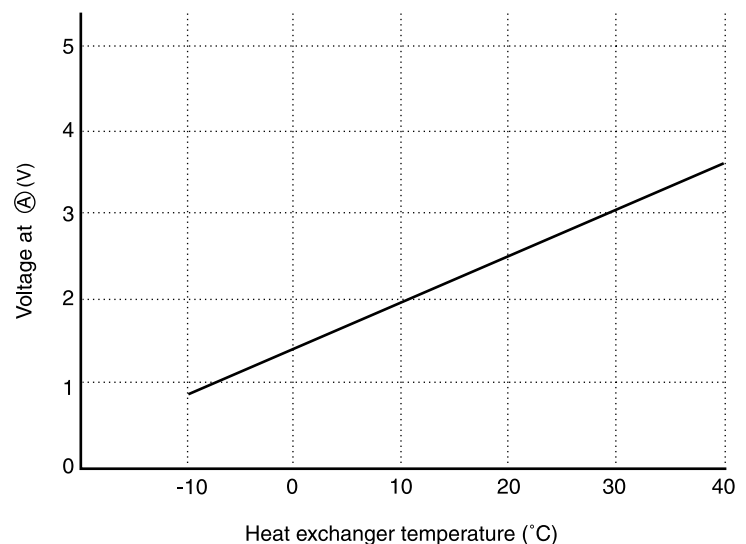

Fig. 6-2

7. Initial Setting Circuit (IC401)

- When power is supplied, the microcomputer reads the data in IC401 or IC402 (E²PROM) and sets the preheating activation value and the rating and maximum speed of the compressor, etc. to their initial values.
- Data of self-diagnosis mode is stored in IC401 or IC402; data will not be erased even when power is turned off.

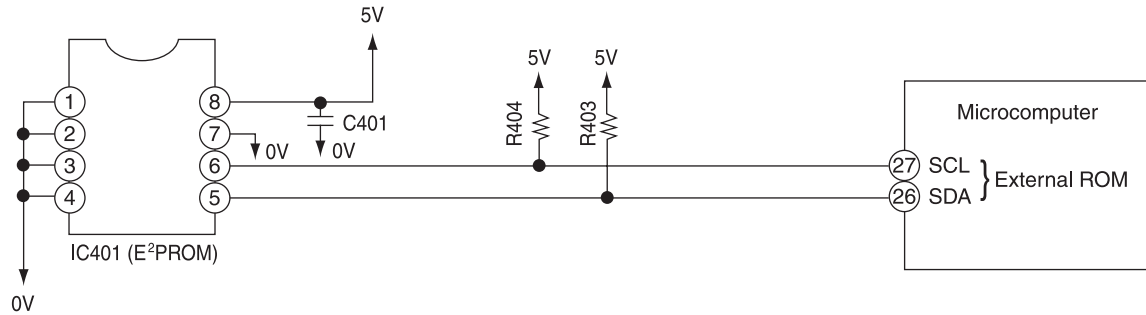

Fig. 7-1

SERVICE CALL Q & A

MODEL RAK-18NH5, RAK-25NH5, RAK-35NH5

COOLING MODE

Q1 The compressor has stopped suddenly during cooling operation.



A1 Check if the indoor heat exchanger is frosted. Wait for 3-4 minutes until it is defrosted.

If the air conditioner operates in cooling mode when it is cold, the evaporator may get frosted.

DEHUMIDIFYING MODE

Q2 Sound of running water is heard from indoor unit during dehumidifying.



A2 Normal sound when refrigerant flows in pipe.

Q3 Compressor occasionally does not operate during dehumidifying.



A3 Compressor may not operate when room temperature is 10°C or less. It also stops when the humidity is preset humidity or less.

HEATING MODE

Q4 The circulation stops occasionally during Heating mode.



A4 It occurs during defrosting. Wait for 5-10 minutes until the condenser is defrosted.

Q5 When the fan speed is set at HIGH or MED, the flow is actually Weak.



A5 At the beginning of heating, the fan speed remains LOW for 30 seconds. If HIGH is selected, it switches to LOW and again to MED after additional 30 seconds.

Q6 Heating operation stops while the temperature is preset at "30".



A6 If temperature is high in the outdoor, heating operation may stop to protect internal devices.

AUTO FRESH DEFROSTING

Q7) After the ON/OFF button is pressed to stop heating, the outdoor unit is still working with the OPERATION lamp lighting.



A7) Auto Fresh Defrosting is carried out : the system checks the outdoor heat exchanger and defrosts it as necessary before stopping operation.

AUTO OPERATION

Q8) Fan speed does not change when fan speed selector is changed during auto operation.



A8) At this point fan speed is automatic.

NICE TEMPERATURE RESERVATION

Q9) When on-timer has been programmed, operation starts before the preset time has been reached.



A9) This is because “Nice temperature reservation” function is operating. This function starts operation earlier so the preset temperature is reached at the preset time. Operation may start maximum 60 minutes before the preset time.

Q10) Does “Nice temperature reservation” function operate during dehumidifying?



A10) It does not work. It works only during cooling and heating.

Q11) Even if the same time is preset, the operation start time varies.



A11) This is because “Nice temperature reservation” function is operating. The start time varies according to the load of room. Since load varies greatly during heating, the operation start time is corrected, so it will vary each day.

INFRARED REMOTE CONTROL

Q12) Timer cannot be set.



A12) Has the clock been set? Timer cannot be set unless the clock has been set.

Q13) The current time display disappears soon.



A13) The current time disappears in approx. 10 seconds. The time set display has priority.

When the current time is set the display flashes for approx 3 minutes.

Q14) The timer has been programmed, but the preset time disappears.



A14) Is the current time past the preset time? When the preset time reaches the current time, it disappears.

OTHERS

Q15 The indoor fan varies among high air flow, low air flow and breeze in the auto fan speed mode. (Heating operation)



A15 This is because the cool wind prevention function is operating, and does not indicate a fault.

The heat exchanger temperature is sensed in the auto speed mode. When the temperature is low, the fan speed varies among high air flow, low air flow and breeze.

Q16 Loud noise from the outdoor unit is heard when operation is started.



A16 When operation is started, the compressor rotation speed goes to maximum to increase the heating or cooling capability, so noise becomes slightly louder. This does not indicate a fault.

Q17 Noise from the outdoor unit occasionally changes.



A17 The compressor rotation speed changes according to the difference between the thermostat set temperature and room temperature. This does not indicate a fault.

Q18 There is a difference between the set temperature and room temperature.



A18 There may be a difference between the set temperature and room temperature because of construction of room, air current, etc. Set the temperature at a comfortable for the space.

Q19 Air does not flow immediately after operation is started.



A19 Preliminary operation is performed for one minute when the power switch on and heating or dehumidifying is set. The operation lamp blinks during this time for heating. This does not indicate a fault.





TROUBLESHOOTING WHEN TIMER LAMP BLINKS.

Model RAK-18NH5, RAK-25NH5, RAK-35NH5

Perform troubleshooting according to the number of times the indoor timer lamp and outdoor LD301 blink.

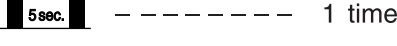
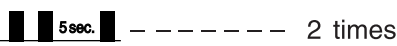
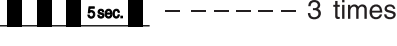
SELF-DIAGNOSIS LIGHTING MODE

Model: RAK-18NH5, RAK-25NH5, RAK-35NH5

No.	Blinking of Timer lamp	Reason for indication	Possible cause
1	 1 time	<u>Reversing valve defective</u> When the indoor heat exchanger temperature is too low in the heating mode or it is too high in the cooling mode.	(1) Reversing valve defective (2) Heat exchanger thermistor disconnected (only in the heating mode) (Note) The malfunction mode is entered the 3rd time this abnormal indication appears (read every 3 minutes).
2	 2 times	<u>Outdoor unit forced operation</u> When the outdoor unit is in forced operation or balancing operation after forced operation	Electrical parts in the outdoor unit
3	 3 times	<u>Indoor/outdoor interface defective</u> When the interface signal from the outdoor unit is interrupted.	(1) Indoor interface circuit (2) Outdoor interface circuit
4	 4 times	Outdoor electrical assembly defective.	Please check at the outdoor electrical led lamp blinking (LD301) and refer to self diagnosis lighting mode for outdoor unit.
5	 9 times	<u>Room thermistor or heat exchanger thermistor is faulty</u> When room thermistor or heat exchanger thermistor is opened circuit or short circuit.	(1) Room thermistor (2) Heat exchanger thermistor
6	 10 times	<u>Over-current detection at the DC fan motor</u> when over-current is detected at the DC fan motor of the indoor unit.	(1) Indoor fan locked (2) Indoor fan motor (3) Indoor control P.W.B.
※1	 13 times	<u>IC401 or IC402 data reading error</u> When data read from IC401 or IC402 is incorrect.	IC401 or IC402 abnormal

( -- Lights for 0.5 sec. at interval of 0.5 sec..)

<Cautions>

- (1) If the interface circuit is faulty when power is supplied, the self-diagnosis display will not be displayed.
- (2) If the indoor unit does not operate at all, check to see if the F-cable is connected or disconnected.
- (3) To check operation again when the timer lamp is blinking, you can use the remote control for operation (except for mode mark ※1).

CHECKING INDOOR UNIT ELECTRICAL PARTS

1. Power does not come on (no operation)

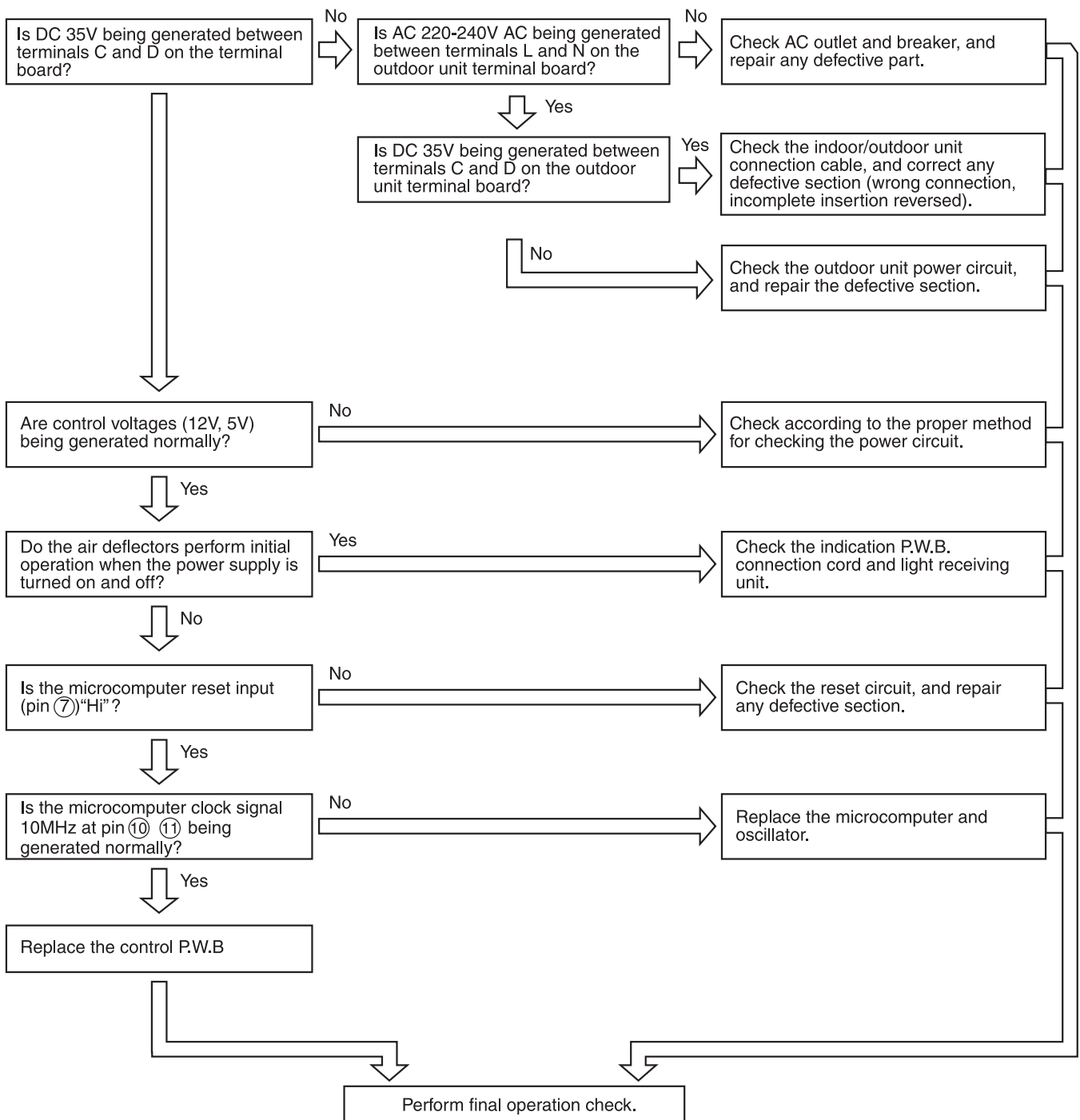

2. Only indoor fan does not operate (other is normal) _____

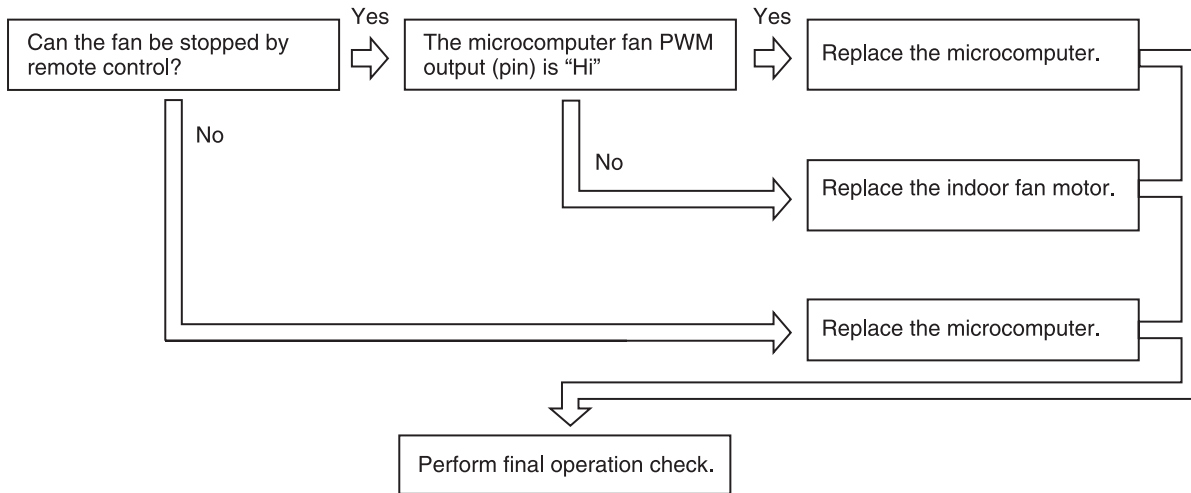

3. Air deflector does not move (others are normal) _____

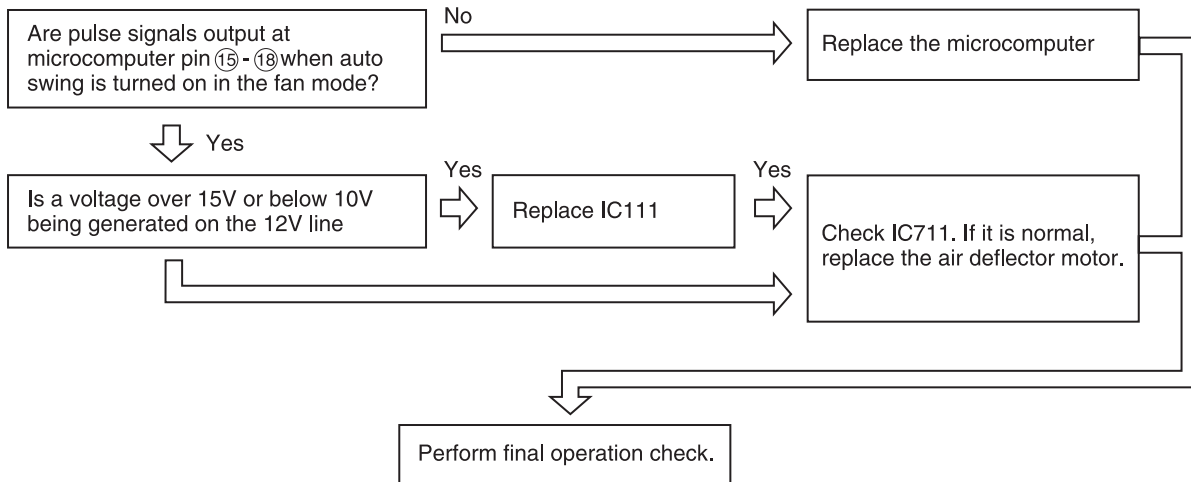

4. All systems stop from several seconds to several minutes after operation is started (all indicators are also off) _____

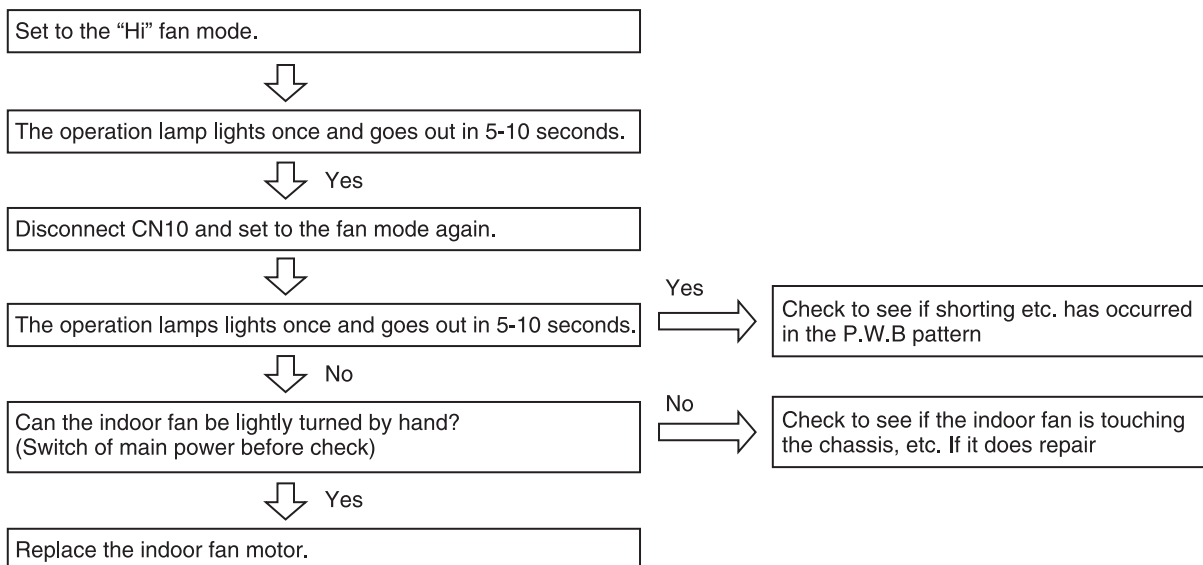

5. Check the main P.W.B (power circuit)

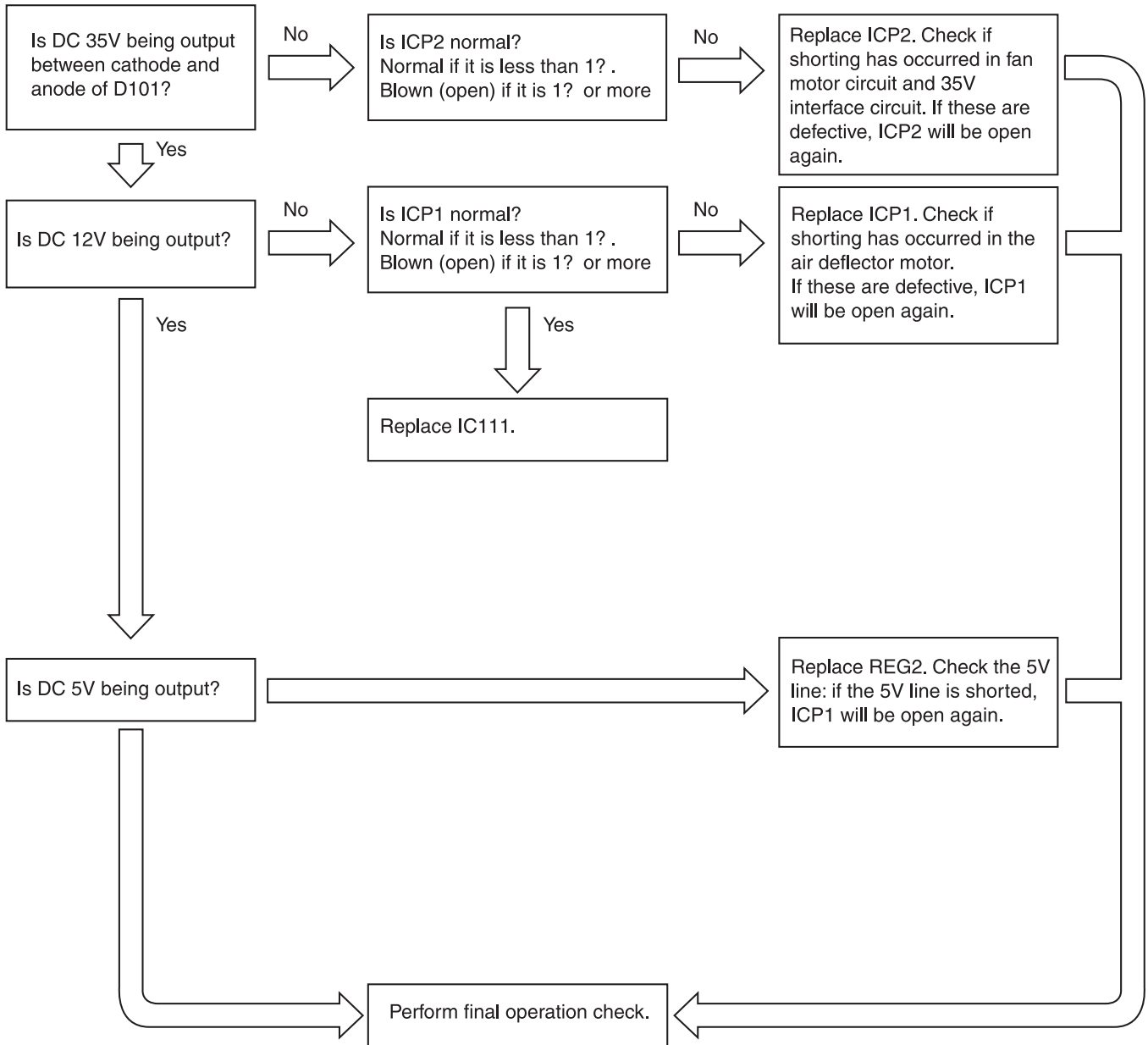

CHECKING THE REMOTE CONTROLLER

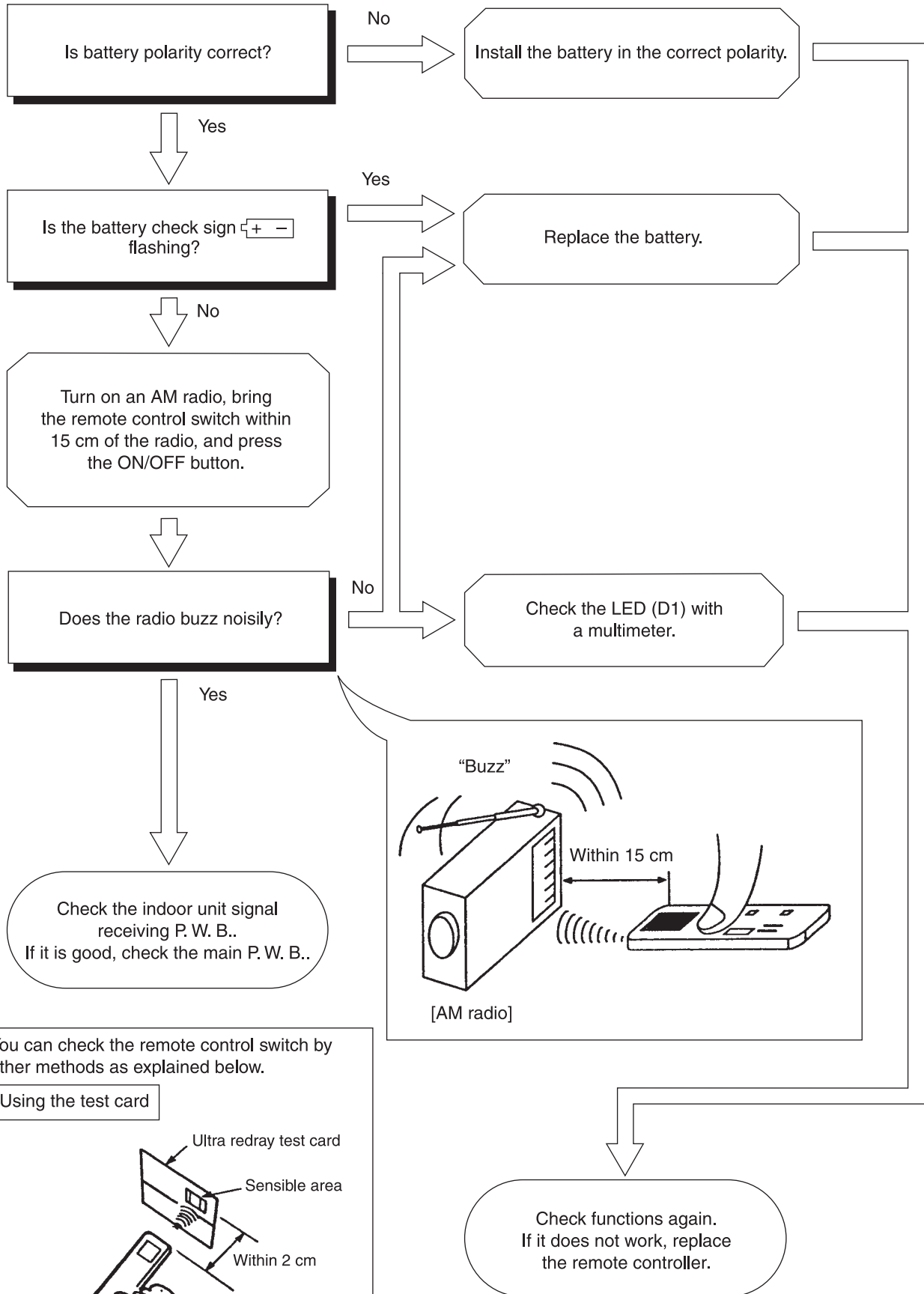

You can check the remote control switch by other methods as explained below.

Using the test card

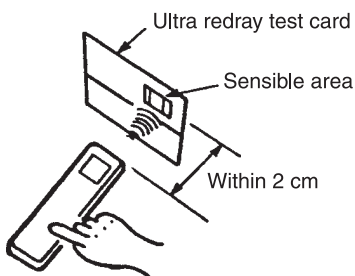

The sensible area should flash in orange when you operate the remote control unit if it is good.

Procedure for Disassembly and Reassembly

INDOOR UNIT RAK-18NH5, RAK-25NH5, RAK-35NH5

1. Front Panel

- (1) Pull up the washable panel by holding it at both lower sides with both hands.

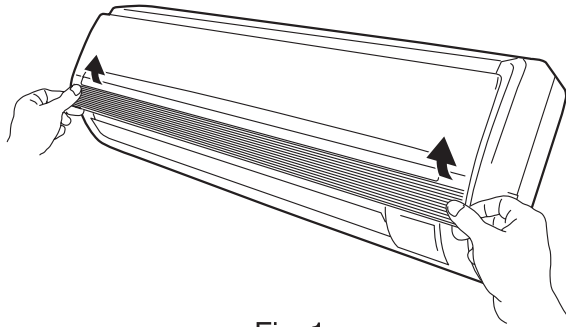

Fig. 1

- (2) When the panel opens full, push the inner part of the right arm into the inside and pull the panel forward while closing it gradually.

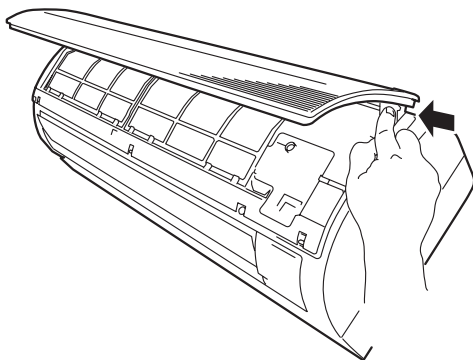

Fig. 2

2. Front cover

- (1) After removing two screws, pull the center of the front cover forward and release the claws.
- (2) Hold the front cover at both lower sides and pull them forward to remove.

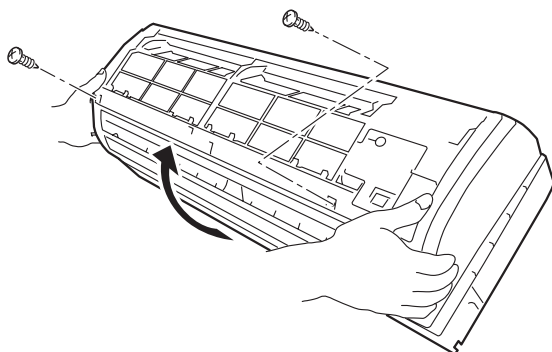

Fig. 3

3. Main P.W.B. and Reception/Indication P.W.B

- (1) Remove each connector from the lead wire.
- (2) Remove the four P.W.B supports from the main P.W.B..
- (3) Pull the support hook at the upper side of the indication lamp of the reception/indication P.W.B and pull out the P.W.B forward.

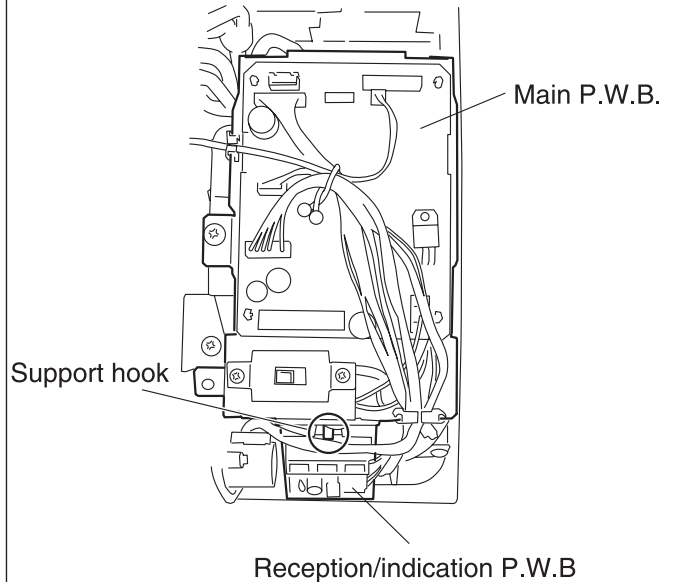

Fig. 4

4. Tangential air flow fan and fan motor

- (1) Remove two screws locking the drain pan.
- (2) Press to lower the hook at the center of the unit a little and pull the claw forward to remove the drain pan.

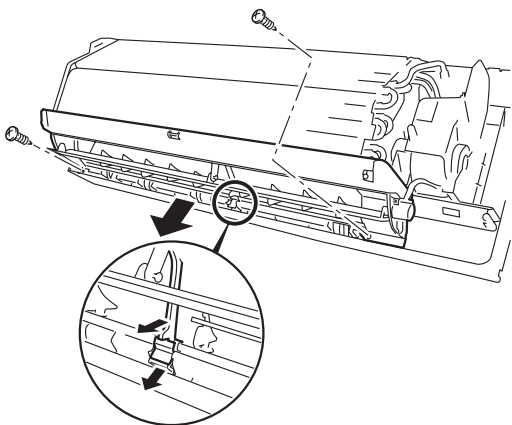

Fig. 5

- (3) Remove the screws from the upper and lower bearing covers.
- (4) Remove the locking hook of the lower bearing cover from the Cabinet.

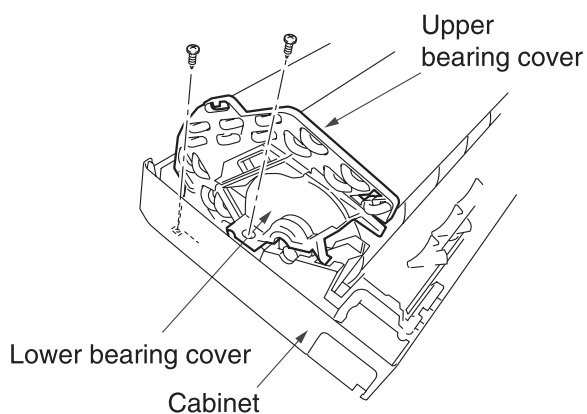

Fig. 6

- (5) Remove two lock screws from the fan motor holder.
- (6) Pull up the evaporator by holding it at the lower side. Insert a screwdriver through the space between the evaporator and drain chute and loosen the fan lock screw to remove the fan and fan motor.

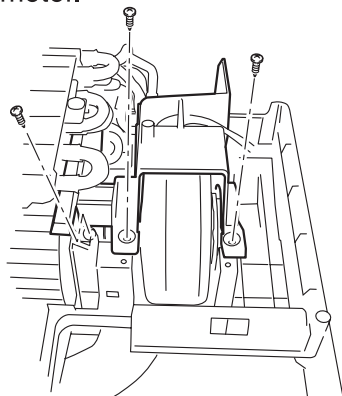
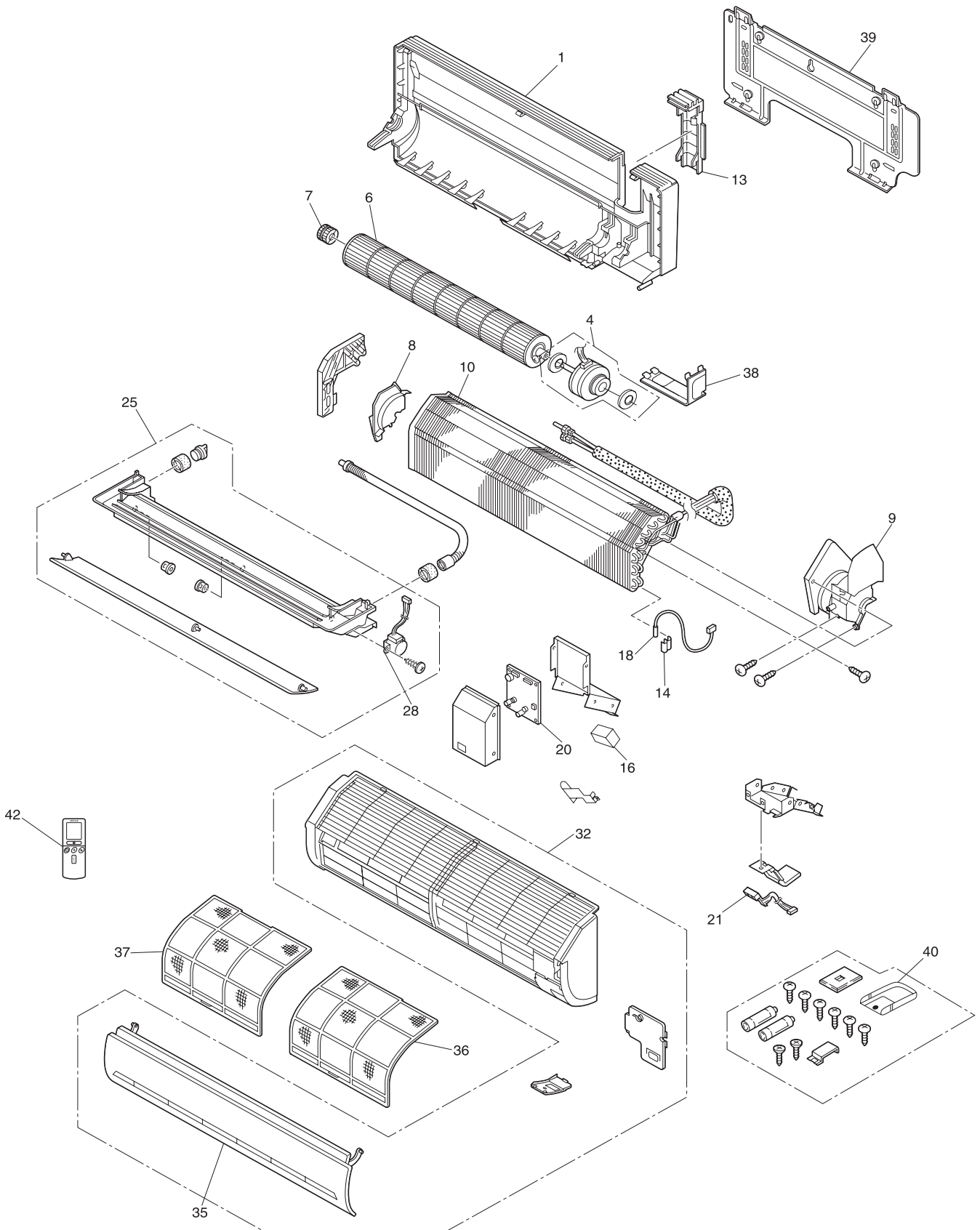

Fig. 7

PARTS LIST AND DIAGRAM

INDOOR UNIT

MODEL: RAK-18NH5, RAK-25NH5, RAK-35NH5



MODEL RAK-25NH5

NO.	PART NO. RAK-25NH5	Q'TY / UNIT	PARTS NAME
1	PMRAS-25YH4 901	1	CABINET
4	PMRAS-25YH4 904	1	FAN MOTOR
6	PMRAS-260GA 001	1	TANGENTIAL AIR FLOW FAN
7	PMRAS-25YH4 908	1	FAN SUPPORT ASSEMBLY
8	PMRAS-25YH4 909	1	FAN COVER
9	PMRAS-25YH4 910	1	FAN MOTOR SUPPORT
10	PMRAK-25NH5 002	1	CYCLE ASSY
13	PMRAS-25YH4 914	1	UPPER COVER
14	PMRAS-25YH4 915	1	SPRING
16	PMRAS-25YH4 917	1	TERMINAL BOARD (2P)
18	PMRAS-260GHA 001	1	THERMISTOR ASSEMBLY
20	PMRAK-25NH5 001	1	P.W.B (MAIN)
21	PMRAS-25YH4 922	1	P.W.B (RECEIVER)
25	PMRAS-25YH4 926	1	DRAIN PAN
28	PMRAS-25YH4 929	1	AUTO SWEEP MOTOR
32	PMRAS-25YH4 933	1	FRONT COVER ASSEMBLY
35	PMRAS-25YH4 936	1	FRONT PANEL
36	PMRAS-25YH4 937	1	AIR FILTER (R)
37	PMRAS-25YH4 938	1	AIR FILTER (L)
38	PMRAS-25YH4 939	1	LOWER COVER
39	PMRAS-25YH4 940	1	MOUNTING PLATE
40	PMRAS-10C3M 003	1	REMOTE CONTROL SUPPORT
42	PMRAS-51CHA1 011	1	REMOTE CONTROL ASSEMBLY

MODEL RAK-35NH5

NO.	PART NO. RAK-35NH5	Q'TY / UNIT	PARTS NAME
1	PMRAS-25YH4 901	1	CABINET
4	PMRAS-25YH4 904	1	FAN MOTOR
6	PMRAS-260GA 001	1	TANGENTIAL AIR FLOW FAN
7	PMRAS-25YH4 908	1	FAN SUPPORT ASSEMBLY
8	PMRAS-25YH4 909	1	FAN COVER
9	PMRAS-25YH4 910	1	FAN MOTOR SUPPORT
10	PMRAK-25NH5 002	1	CYCLE ASSY
13	PMRAS-25YH4 914	1	UPPER COVER
14	PMRAS-25YH4 915	1	SPRING
16	PMRAS-25YH4 917	1	TERMINAL BOARD (2P)
18	PMRAS-260GHA 001	1	THERMISTOR ASSEMBLY
20	PMRAK-35NH5 001	1	P.W.B (MAIN)
21	PMRAS-25YH4 922	1	P.W.B (RECEIVER)
25	PMRAS-25YH4 926	1	DRAIN PAN
28	PMRAS-25YH4 929	1	AUTO SWEEP MOTOR
32	PMRAS-25YH4 933	1	FRONT COVER ASSEMBLY
35	PMRAS-25YH4 936	1	FRONT PANEL
36	PMRAS-25YH4 937	1	AIR FILTER (R)
37	PMRAS-25YH4 938	1	AIR FILTER (L)
38	PMRAS-25YH4 939	1	LOWER COVER
39	PMRAS-25YH4 940	1	MOUNTING PLATE
40	PMRAS-10C3M 003	1	REMOTE CONTROL SUPPORT
42	PMRAS-51CHA1 011	1	REMOTE CONTROL ASSEMBLY

HITACHI

RAK-18NH5
RAK-25NH5
RAK-35NH5

PM NO. 0269E

Printed in Malaysia